



Dell Accessories eGuide - Offline PDF

For the best browsing experience
with direct access to videos and external links,

[Click to access the online eGuide](#)

WORK CONFIDENTLY, ANYWHERE.

Complete your work setup with the right tools to maximize your work performance. Engineered to work seamlessly with Dell systems, our broad portfolio of PC accessories meets your end-to-end needs, no matter where work takes you.

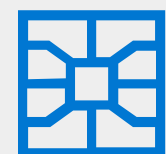

FLEXIBLE SOLUTIONS TAILORED TO YOUR NEEDS

Customize your workspace and boost productivity with Dell Accessories. Our intelligent and innovative solutions keep you connected and more collaborative, creating a perfect workspace, wherever you want it to be.



INTELLIGENT DESIGN

Work smarter with carefully designed accessories that offer future-ready connectivity, long-lasting battery life, comfort and security features.



SEAMLESS INTEGRATION

Complete your setup with our extensive range of accessories, designed, tested and certified to work seamlessly with Dell systems. Backed by world-class service and support, our solutions are easily available from a single source.



**EXPLORE
ACCESSORIES**



**KEYBOARDS &
MICE, ACTIVE PENS**

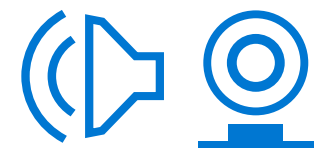

WEBCAM & AUDIO



DOCKS



**ADAPTERS
& POWERBANKS**



CHARGING CARTS & KITS



ARMS & STANDS



CARRYING CASES



SOFTWARE



DELLTechnologies



DELL

KEYBOARDS, MICE & ACTIVE PENS

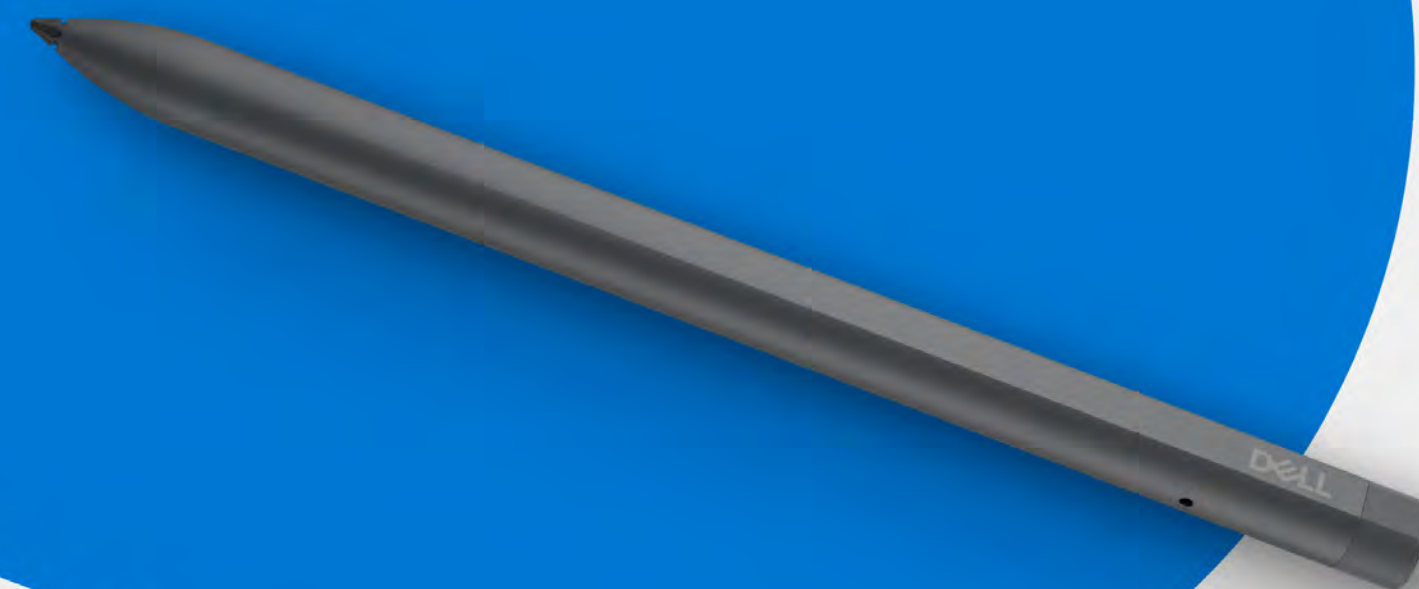



KEYBOARDS, MICE & ACTIVE PENS



Enhance productivity with Dell keyboards, mice and active pens, thoughtfully designed to deliver maximum comfort and performance.



COMFORT

Designed for all-day comfort and ease of use.

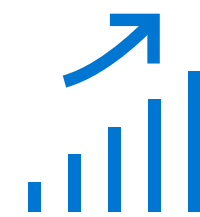

ENHANCED PRODUCTIVITY

Shortcuts, customizations and multi-device pairing with Dell Peripheral Manager for enhanced productivity.



LASTING PERFORMANCE

Up to 36 months of battery life¹ with 3-Year Advanced Exchange Service² for peace of mind.

Wireless Keyboard and Mouse Combos



Wireless and wired Keyboards



Wireless and wired Mice



Active Pens



¹ Applicable to select models only, please refer to product pages on Dell.com for more information. Based on Dell analysis of battery life usage model calculations. Results vary depending on use, operating conditions and other factors.
² Replacement part/unit dispatched, if needed, following completion of phone/online diagnosis. Fee charged for failure to return defective unit. Availability varies.

INCREASED PRODUCTIVITY

Whether you're at home or in the office, a wireless keyboard or mouse will work seamlessly with your Dell PC, enabling you to do your best work and boosting your productivity by up to 25.8%.*

*Source: A Hot Tech Vision and Analysis study commissioned by Dell Technologies, "Dell Monitor Productivity Story - Examining the Effects of External Monitors on Remote Worker Productivity", June 2020. Actual results will vary. Full report: <https://www.dell.com/resources/en-us/asset/white-papers/products/electronics-accessories/dell-monitor-productivity-study-hot-tech.pdf>



CRAFTED FOR COMFORT

Stylish and innovative, our keyboards, mice and active pens are designed with unique features to provide maximum comfort and ease of use.

Well-designed
contoured mouse
that fits perfectly
in your hand



Cone-shaped nib
designed for a natural
and comfortable
writing experience

Premium-feel keyboard with quiet keys that offer
a light and responsive typing experience

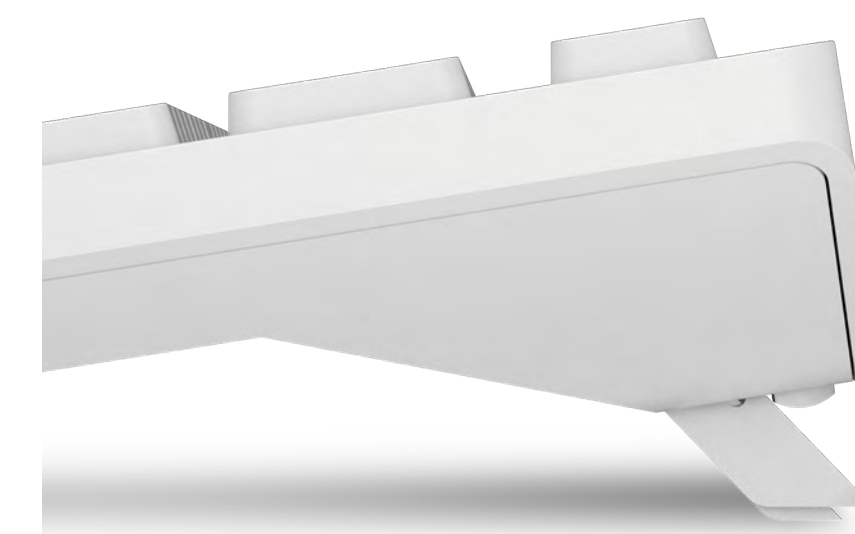

Adjustable tilt legs create
the optimal typing position





DELL

KEYBOARDS & MICE





WHAT'S NEW

DELL PREMIER COLLABORATION KEYBOARD – KB900

Collaborate effortlessly with the World's first rechargeable keyboard certified by Zoom¹, featuring touch controls, extensive connectivity options, backlighting and customizable keys.

**World's first collaboration
keyboard certified by Zoom¹**



EFFORTLESS AND SECURE COLLABORATION

Confidently control calls with illuminated Zoom touch controls, and effortlessly switch between up to 3 devices by pressing a key thanks to easy and secure Bluetooth and Dell Secure Link (RF) connectivity.

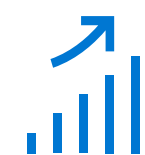

ENHANCED EFFICIENCY

Personalize your keyboard by creating shortcuts with 15 programmable keys and control the smart backlighting to work easily in the dark. Thoughtfully designed keys with scissor switch mechanism offer a responsive and quiet typing experience.



BUILT TO LAST

Recharge using USB-C and get up to 20 days battery life, or fast charge in one minute for a full day's use.² Enjoy peace of mind with the Dell 3-year Advanced Exchange Service.³

Product availability may vary by country, please refer to the product page on Dell.com for more information.

¹ Based on Dell analysis of publicly available information of competitive personal zoom room keyboards, August 2022.

² Battery life calculation based on an assumption of an average use of 8 hours a day. Battery life may vary depending on user and computing conditions.

³ Advanced Exchange Service: Dell will send you a replacement product the next business day in most cases, if deemed necessary after phone/online diagnosis. Shipping times may vary by location. Fee charged for failure to return defective unit. See dell.com/servicecontracts/global.



WHAT'S NEW

DELL PREMIER RECHARGEABLE MOUSE – MS900

Masterfully crafted for optimal all-day comfort, this premium mouse features advanced four-way scrolling and long-lasting battery life.¹

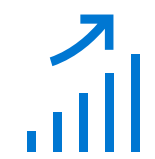

COMFORT AND PRODUCTIVITY

Featuring a smooth, elegant design and comfortable grip, this premium mouse is designed for optimal full-day use while horizontal and vertical scroll wheels deliver more efficient navigation.



PERSONALIZED TO GET MORE DONE

Create shortcuts and customizations with Dell Peripheral Manager and five programmable buttons, and enjoy enhanced sensitivity and precision with adjustable DPI and smooth tracking on virtually all surfaces.



BUILT TO LAST

Enjoy up to three months¹ battery life on a single charge or fast charge via USB-C 1 min for half day use. Covered by the Dell 3-year Advanced Exchange Service.²

Product availability may vary by country, please refer to the product page on Dell.com for more information.

¹ Battery life calculation based on an assumption of an average use of 8 hours a day. Battery life may vary depending on user and computing conditions.

² Advanced Exchange Service: Dell will send you a replacement product the next business day in most cases, if deemed necessary after phone/online diagnosis. Shipping times may vary by location. Fee charged for failure to return defective unit. See dell.com/servicecontracts/global.



WIRELESS KEYBOARD & MOUSE COMBOS



Dell Premier Collaboration Keyboard and Mouse – KM900

- 2.4 GHz RF (Dell Secure Link) + Bluetooth 5.1; Connect up to 3 devices
- Premium sleek keyboard with Zoom touch controls & contoured mouse with vertical & horizontal scroll wheels
- 20d/3m battery life for keyboard & mouse respectively on single charge³
- Up to 8000 DPI; Programmable via Dell Peripheral Manager
- 3-Year Advanced Exchange Service²



[Read More](#)

Dell Premier Wireless Keyboard and Mouse – KM7321W

- 2.4 GHz RF + Bluetooth 5.0; Connect up to 3 devices
- Full-size, sleek keyboard and sculpted mouse with 7 buttons
- Up to 4000 adjustable DPI
- Programmable via Dell Peripheral Manager
- 3-Year Advanced Exchange Service²



[Read More](#)

Dell Multi-Device Wireless Keyboard and Mouse – KM7120W

- 2.4 GHz RF + Bluetooth 5.0; Connect up to 3 devices
- Compact keyboard and sculpted mouse with 7 buttons
- Up to 4000 adjustable DPI
- Programmable via Dell Peripheral Manager
- 3-Year Advanced Exchange Service²

[Read More](#)

Product availability may vary by country, please refer to the product page on Dell.com for more information.

¹ Based on Dell analysis of battery life usage model calculations, Nov. 2020. Results vary depending on use, operating conditions and other factors.

² Replacement part/unit dispatched, if needed, following completion of phone/online diagnosis. Fee charged for failure to return defective unit. Availability varies.

³ Battery life calculation based on an assumption of an average use of 8 hours a day. Battery life may vary depending on user and computing conditions.





WIRELESS KEYBOARD & MOUSE COMBOS



Dell Pro Wireless Keyboard and Mouse – KM5221W

- 2.4 GHz RF
- Full-size keyboard and ambidextrous mouse with 3 buttons
- Up to 4000 adjustable DPI
- Programmable via Dell Peripheral Manager
- 3-Year Advanced Exchange Service²



[Read More](#)



Dell Wireless Keyboard and Mouse – KM3322W

- 2.4 GHz RF
- Full-size keyboard and ambidextrous mouse with 3 buttons
- 1000 DPI mouse
- Spill-resistant keyboard and anti-fade keys
- 3-Year Advanced Exchange Service²



[Read More](#)

Product availability may vary by country, please refer to the product page on Dell.com for more information.

¹ Based on Dell analysis of battery life usage model calculations, Nov. 2020. Results vary depending on use, operating conditions and other factors.

² Replacement part/unit dispatched, if needed, following completion of phone/online diagnosis. Fee charged for failure to return defective unit. Availability varies.

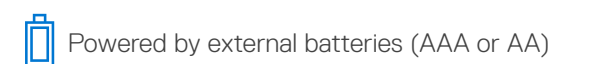



WIRELESS KEYBOARDS



Dell Premier Collaboration Keyboard – KB900

- 2.4 GHz RF (Dell Secure Link) + Bluetooth 5.1; Connect up to 3 devices
- Sleek design with dedicated Zoom touch controls
- Intelligent backlighting with proximity detection
- 20 days battery life on single charge³
- 15 programmable keys via Dell Peripheral Manager
- 3-Year Advanced Exchange Service²



[Read More](#)

Dell Multi-Device Wireless Keyboard – KB700

- 2.4 GHz RF + Bluetooth 5.0; Connect up to 3 devices
- Premium full-size design with scissors keys
- 12 programmable keys via Dell Peripheral Manager
- 3-Year Advanced Exchange Service²



[Read More](#)

Dell Compact Multi-Device Wireless Keyboard – KB740

- 2.4 GHz RF + Bluetooth 5.0; Connect up to 3 devices
- Compact design with scissors keys
- 12 programmable keys via Dell Peripheral Manager
- 3-Year Advanced Exchange Service²



[Read More](#)

Dell Wireless Keyboard – KB500

- 2.4 GHz RF
- Full-size with plunger keys and spill resistant
- 12 programmable keys via Dell Peripheral Manager
- 3-Year Advanced Exchange Service²



[Read More](#)

Product availability may vary by country, please refer to the product page on Dell.com for more information.

¹ Based on Dell analysis of battery life usage model calculations, Nov. 2020. Results vary depending on use, operating conditions and other factors.

² Replacement part/unit dispatched, if needed, following completion of phone/online diagnosis. Fee charged for failure to return defective unit. Availability varies.

³ Battery life calculation based on an assumption of an average use of 8 hours a day. Battery life may vary depending on user and computing conditions.

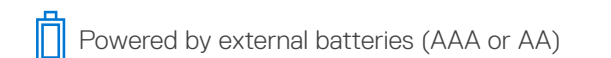



WIRED KEYBOARDS



Dell Smartcard Keyboard – KB813

- Wired USB 2.0
- Full-size with plunger keys and spill-resistant
- Integrated smartcard reader (ISO/IEC 7810/ 7816 ID-1)
- Palm rest (available separately)
- 1-Year Limited Hardware Warranty¹

[Read More](#)



Dell Business Multimedia Keyboard – KB522

- Wired USB 2.0
- Full-size with plunger keys and spill-resistant
- Multimedia keys and volume control knob
- Palm rest (available separately)
- 1-Year Limited Hardware Warranty¹

[Read More](#)



Dell Business Multimedia Keyboard – KB216

- Wired USB 2.0
- Full-size with plunger keys and spill-resistant
- Hot keys with multi-media keys
- Palm rest detachable
- 1-Year Limited Hardware Warranty¹

[Read More](#)

¹Product availability may vary by country, please refer to the product page on Dell.com for more information.

¹Replacement part/unit dispatched, if needed, following completion of phone/online diagnosis. Fee charged for failure to return defective unit. Availability varies.



WIRELESS MICE



Dell Premier Rechargeable Mouse – MS900

- 2.4 GHz RF (Dell Secure Link) + Bluetooth 5.1; Connect up to 3 devices
- Contoured shape with vertical & horizontal scroll wheels and 7 buttons
- 3-month battery life with single charge.²
- Up to 8000 DPI; Programmable via DPM
- 3-Year Advanced Exchange Service⁴



[Read More](#)

Dell Bluetooth Travel Mouse – MS700

- Bluetooth 5.0 & connects up to 3 devices
- Twistable and ambidextrous design with touch scroll
- 24-month battery life¹
- Programmable via Dell Peripheral Manager
- 3-Year Advanced Exchange Service⁴



[Read More](#)

Dell Premier Rechargeable Wireless Mouse – MS7421W

- 2.4 GHz RF + Bluetooth 5.0; Connect up to 3 devices
- Compact and sculpted - 7 buttons
- 6-mth battery on single charge²; 2-min charge lasts up to 8 hrs²
- Up to 4000 adjustable DPI
- Programmable via Dell Peripheral Manager



[Read More](#)

Dell Multi-Device Wireless Mouse – MS5320W

- 2.4 GHz RF + Bluetooth 5.0; Connect up to 3 devices
- Full-size and sculpted with 7 buttons
- Up to 4000 adjustable DPI
- Programmable via Dell Peripheral Manager
- 3-Year Advanced Exchange Service⁴

[Read More](#)

Product availability may vary by country, please refer to the product page on Dell.com for more information. ¹ Based on Dell analysis of battery life usage model calculations, Nov. 2020. Results vary depending on use, operating conditions and other factors. ² Battery life calculation based on an assumption of an average use of 8 hours a day. Battery life may vary depending on user and computing conditions. ³ Battery life may vary based on usage and computing conditions. ⁴ Replacement part/unit dispatched, if needed, following completion of phone/online diagnosis. Fee charged for failure to return defective unit. Availability varies.





WIRELESS MICE

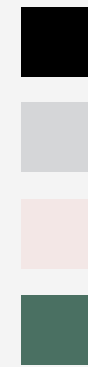

Dell Mobile Pro Wireless Mouse – MS5120W

- 2.4 GHz RF + Bluetooth 5.0; Connect up to 2 devices
- Compact with 7 buttons
- Up to 4000 adjustable DPI
- Programmable via Dell Peripheral Manager
- 3-Year Advanced Exchange Service⁴



[Read More](#)

Dell Mobile Wireless Mouse – MS3320W

- 2.4 GHz RF + Bluetooth 5.0; Connect up to 2 devices
- Compact & ambidextrous - 3 buttons
- Up to 4000 adjustable DPI
- Programmable via Dell Peripheral Manager
- 3-Year Advanced Exchange Service⁴

[Read More](#)

Dell Full-size Wireless Mouse – MS300

- RF 2.4 GHz
- Full-size and ambidextrous with 3 buttons
- Up to 4000 DPI
- Programmable via Dell Peripheral Manager
- 3-Year Advanced Exchange Service⁴

[Read More](#)

Dell Wireless Mouse – WM126

- 2.4 GHz RF
- Compact and ambidextrous with 3 buttons
- 1000 DPI
- 1-Year Limited Hardware Warranty⁴



[Read More](#)

Product availability may vary by country, please refer to the product page on Dell.com for more information. ¹ Based on Dell analysis of battery life usage model calculations, Nov. 2020. Results vary depending on use, operating conditions and other factors. ² Battery life calculation based on an assumption of an average use of 8 hours a day. Battery life may vary depending on user and computing conditions. ³ Battery life may vary based on usage and computing conditions. ⁴ Replacement part/unit dispatched, if needed, following completion of phone/online diagnosis. Fee charged for failure to return defective unit. Availability varies.

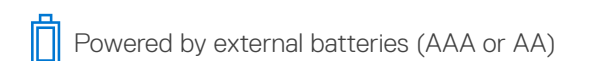



WIRED MICE



Dell Wired Mouse with Fingerprint Reader – MS819

- Wired USB 2.0
- Full-size and ambidextrous with 3 buttons
- Integrated fingerprint reader for Windows Hello; FIDO & GS-mark ready
- 1000 DPI
- 1-Year Limited Hardware Warranty¹

[Read More](#)

Dell Laser Wired Mouse – MS3220

- Wired USB 2.0
- Full-size with 5 buttons
- Up to 3200 DPI with DPI switch
- Programmable via Dell Peripheral Manager
- 1-Year Limited Hardware Warranty¹

[Read More](#)

Dell Optical Mouse – MS116

- Wired USB 2.0
- Full-size and ambidextrous with 3 buttons
- Optical LED sensor, 1000 DPI
- 1-Year Limited Hardware Warranty¹

[Read More](#)

Product availability may vary by country, please refer to the product page on Dell.com for more information.

¹ Replacement part/unit dispatched, if needed, following completion of phone/online diagnosis. Fee charged for failure to return defective unit. Availability varies.

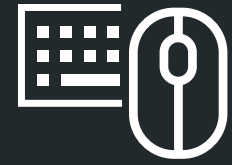

DELL PERIPHERAL MANAGER FOR KEYBOARDS & MICE

Enjoy the convenience of having quick access to dedicated keys and programmable shortcuts. Dell Peripheral Manager is your one-stop software center that lets you customize your keyboards and mice to suit your needs.

[LEARN MORE ABOUT DELL PERIPHERAL MANAGER](#)



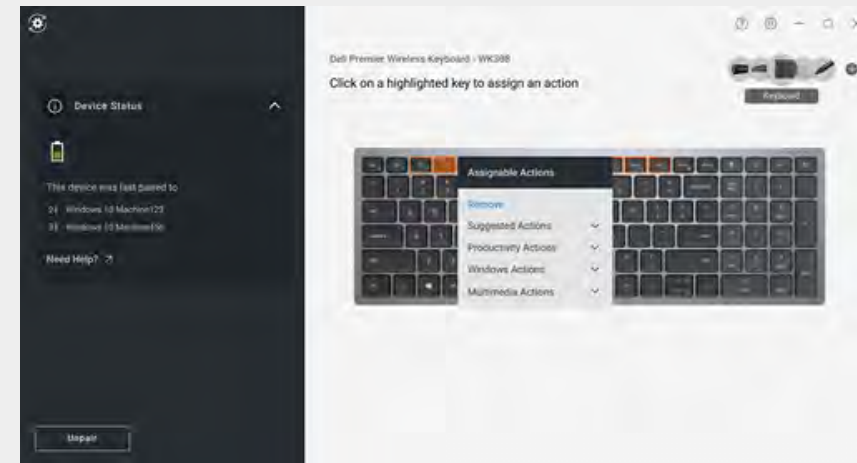

CUSTOMISE THE WAY YOU WORK

Gain instant access to frequently-used applications and functions by programming the keys and buttons according to your preference. Enjoy the convenience of performing repeated tasks with just one click.



PRECISE NAVIGATION

Adjust your mouse to your preferred DPI for precise navigation across monitors of varying resolutions.



PAIRING MADE EASY

Connect up to 6 devices with one Dell Universal Pairing USB receiver via the software. Easily pair and unpair additional devices.

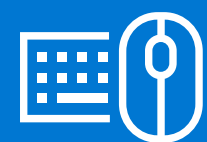

DELL PERIPHERAL MANAGER FOR KEYBOARDS & MICE



CHECK CONNECTIVITY AND BATTERY STATUS

Quickly view your device's battery life and check how it's been paired with your PC.

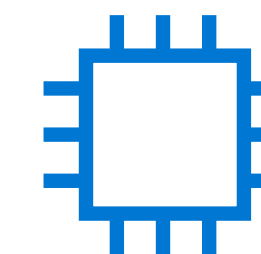

FIRMWARE UPDATES

Keep your devices up to date with the latest firmware, for maximum efficiency.



ACTIVE PENS

[Dell Premier Rechargeable Active Pen – PN7522W](#)





ACTIVE PENS



40 D²



12 M¹



12 M¹



Dell Premier Rechargeable Active Pen

– PN7522W

- AES1.0 & 2.0, WGP protocol
- 4096 levels of Pressure sensitivity with tilt supported; Tile location tracker
- Rechargeable battery last up to 40 days on single charge¹
- Sensitivity adjustable and buttons programmable via Dell Peripheral Manager
- Spare nibs included²

[Read More](#)

Dell Premium Active Pen

– PN579X

- AES1.0 & 2.0, MPP 1.51
- 4096 levels of Pressure sensitivity with tilt supported
- AAAA battery lasts up to 12-month¹
- Customizable buttons via Active Pen control Panel
- 1-Year Limited Hardware Warranty²

[Read More](#)

Dell Active Pen

– PN5122W

- AES1.0 & 2.0, WGP protocol
- 4096 levels of Pressure sensitivity with tilt supported
- AAAA battery lasts up to 12-month¹
- Sensitivity adjustable and buttons programmable via Dell Peripheral Manager
- Spare nibs included & 3-Year Advanced Exchange Service²

[Read More](#)

Product availability may vary by country, please refer to the product page on Dell.com for more information.

¹ Based on Dell analysis of battery life usage model calculations, Nov. 2020. Results vary depending on use, operating conditions and other factors.

² Replacement part/unit dispatched, if needed, following completion of phone/online diagnosis. Fee charged for failure to return defective unit. Availability varies





DELL PERIPHERAL MANAGER FOR ACTIVE PENS

Optimize the way you work by creating programmable shortcut buttons and customizations using Dell Peripheral Manager software.

ENHANCED WRITING EXPERIENCE

Adjust the levels of tip and tilt sensitivity for a more natural writing experience.

OPTIMIZE YOUR PRODUCTIVITY

Customizable shortcut buttons offer quick access to frequently-used apps or functions.

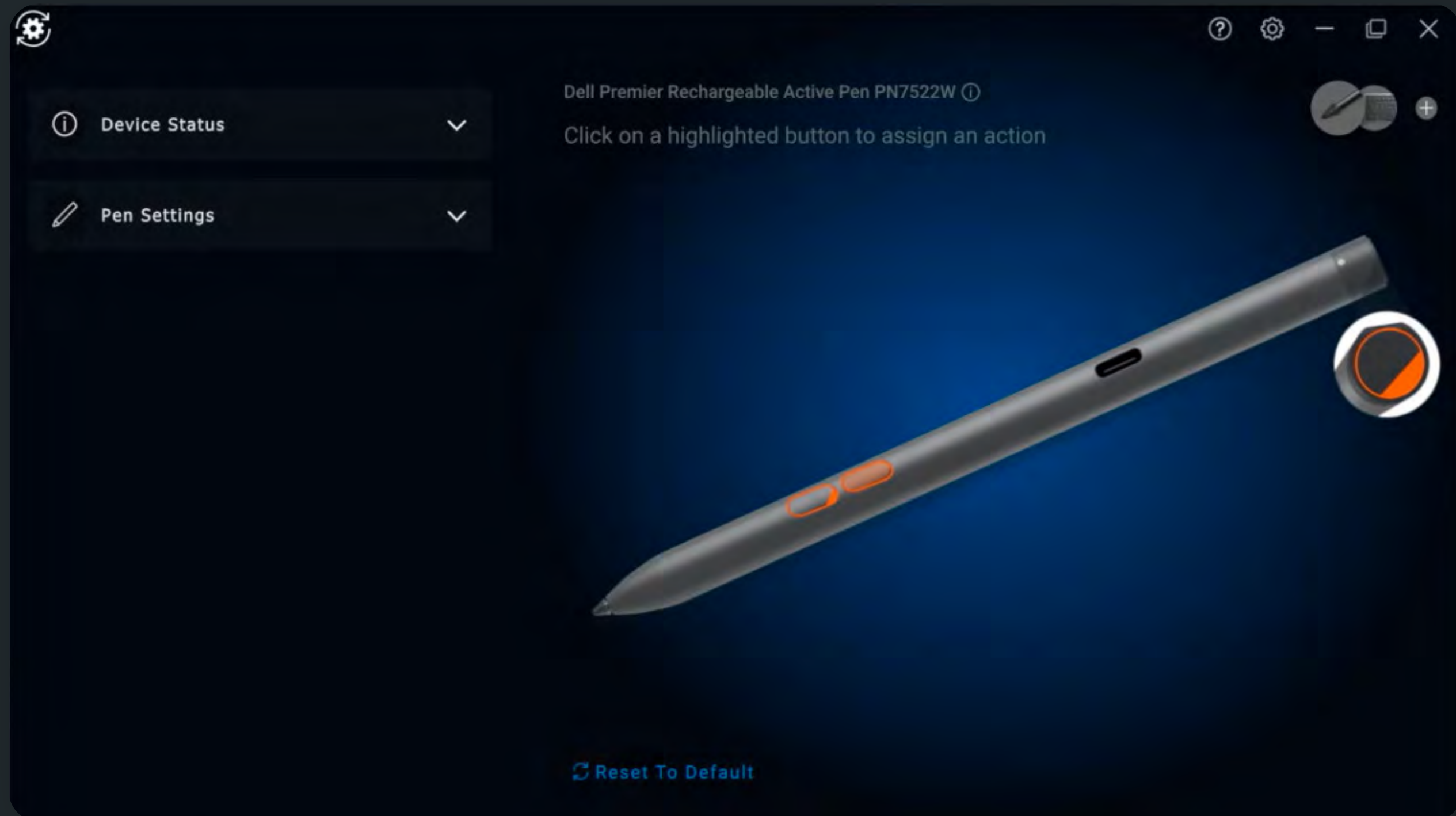

[LEARN MORE ABOUT DELL PERIPHERAL MANAGER](#)

DELLTechnologies



**WEBCAM
& AUDIO**

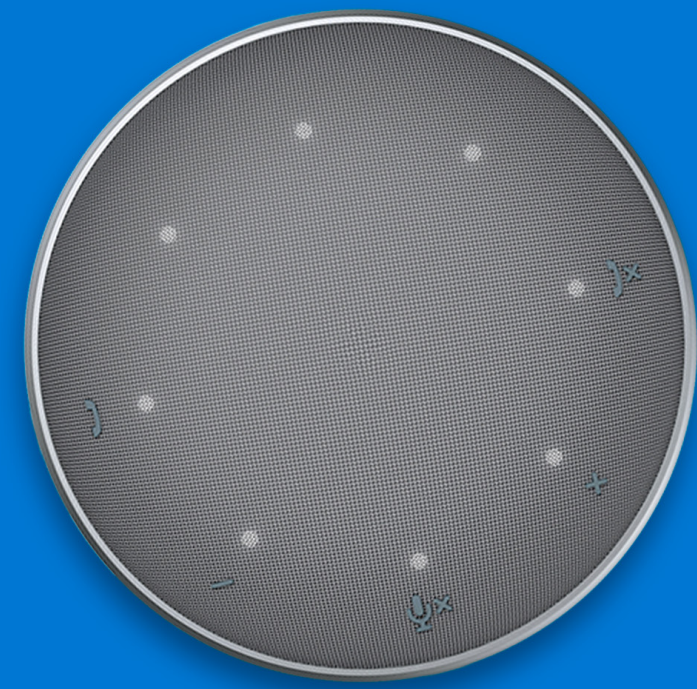
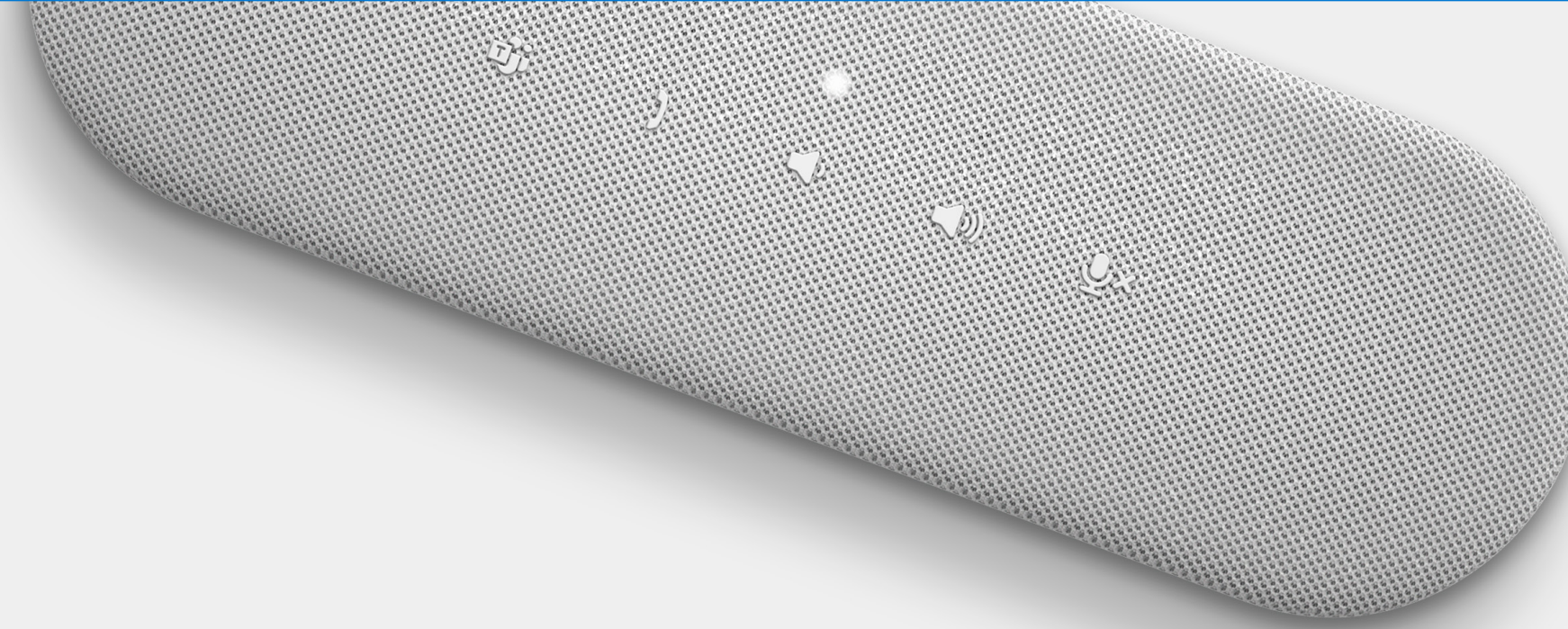

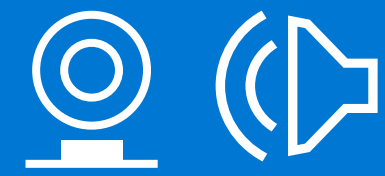

WEBCAM & AUDIO



Collaboration solutions have become critical for organizations to stay connected. Engineered with intelligent features, Dell Webcam & Audio devices allow you to connect and collaborate with ease no matter where you work.

Webcams

Elevate your video-conferencing experience with Dell webcams that deliver professional-grade video quality with built-in intelligent features.



Headsets

Enjoy superior call clarity with these headsets that provide a comfortable and distraction-free calling experience. Collaborate with ease anywhere with our range of Teams and Zoom certified headsets, also compatible with leading UC platforms.



Speakerphones

Designed to provide clearer and easier communication, these speakerphones offer a great hands-free conferencing experience at home, at work or on the go.



Soundbars

Add a rich audio solution to your setup with Dell soundbars that perfectly complement your Dell monitors in design, offering a clean desk experience.





WEBCAM





WEBCAM KEY FEATURES



Look great, always

Engineered with intelligent features, Dell's webcams deliver sharp, bright and outstanding video quality, elevating your video conferencing experience.



Stunning clarity

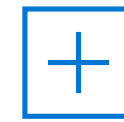
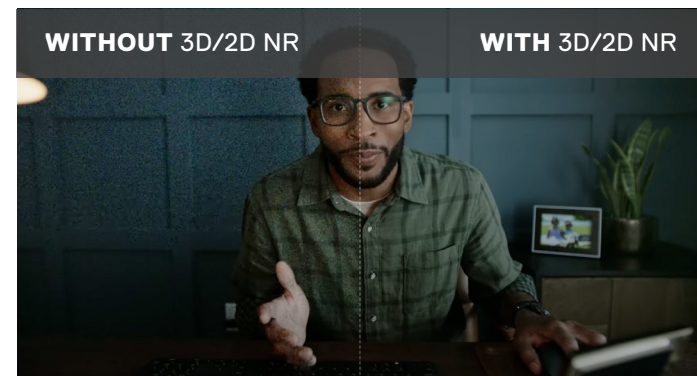

Automatically eliminates grainy images

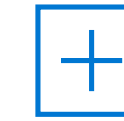

Look your best even in extreme lighting conditions



Intelligent framing to keep you centered



Get to work, fast



Adjustable Field of View (FOV)



Protect your webcam lens, and your privacy

All images shown on this page are for illustration purposes only. Product availability may vary by region and product features may vary by model; please refer to Dell.com for more details.
1 Based on internal analysis of external 4K personal conferencing webcams, April 2012.

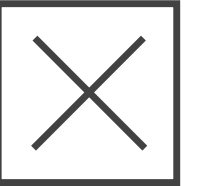

Automatically eliminates grainy images

Temporal Noise Reduction (3DNR) and Spatial Noise Reduction (2DNR) eliminates motion blur and grainy images, ensuring crisp and clear picture quality even in low light.



Product availability may vary by region and product features may vary by model; please refer to [Dell.com](https://www.dell.com) for more details.
All images shown on this page are for illustrative purposes only.

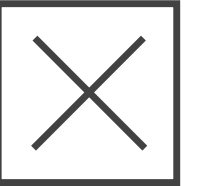

Look your best

The perfect combination of Digital Overlap HDR (DOL-HDR) and Facial Detection Auto Exposure (FDAE), automatically optimizes image quality to help you look your best, always.



Product availability may vary by region and product features may vary by model; please refer to [Dell.com](https://www.dell.com) for more details.
All images shown on this page are for illustration purposes only.

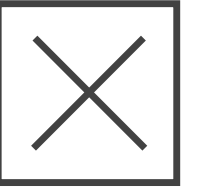

Intelligent framing to keep you centered

Advanced AI auto-framing tracks your movement, keeping you at the center of the frame, however you move.



Product availability may vary by region and product features may vary by model; please refer to [Dell.com](https://www.dell.com) for more details.

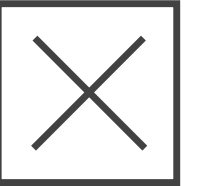

Stunning clarity

Choose between a 4K UHD or a 2K QHD webcam with a large Sony STARVIS™ sensor, that takes in substantial light, providing vibrant images.

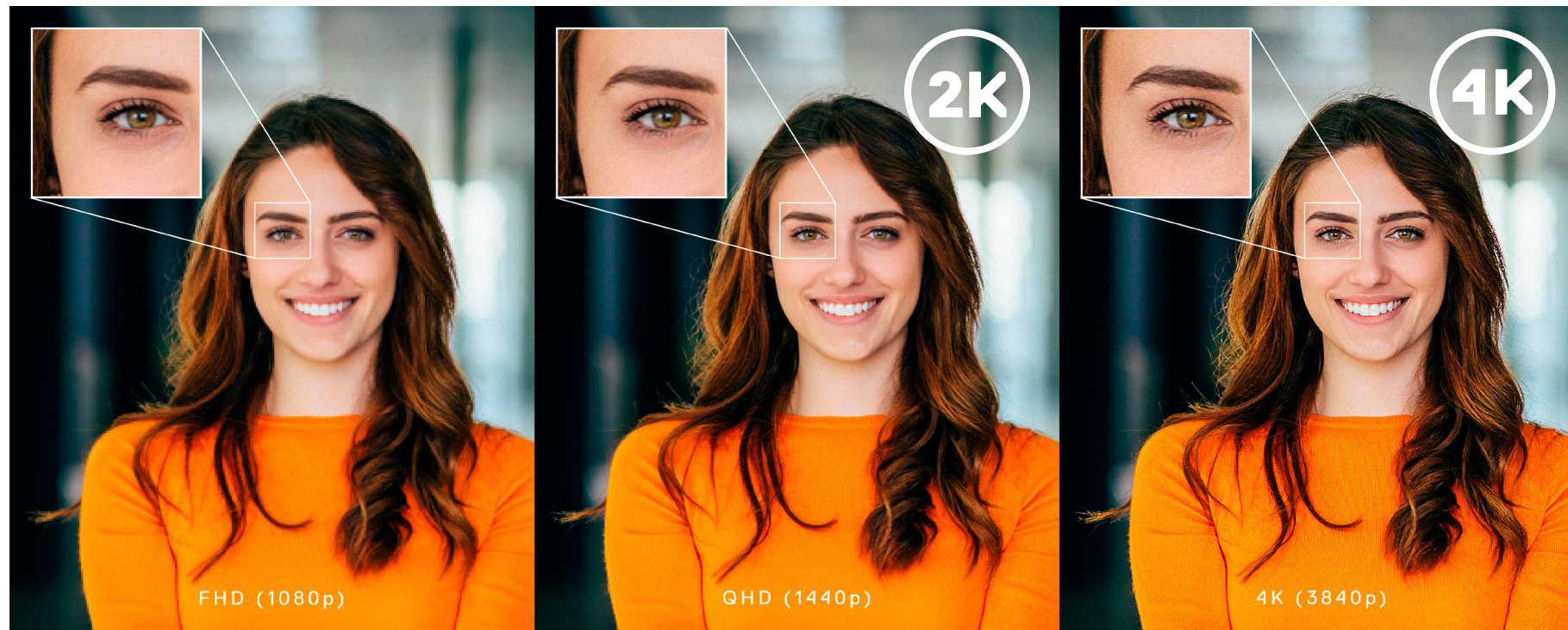

Industry Webcams

Dell Pro Webcam
- WB5023

Dell UltraSharp Webcam - WB7022

Product availability may vary by region and product features may vary by model; please refer to Dell.com for more details. All images shown on this page are for illustrative purposes only.

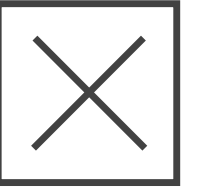

Dell ExpressSign-in

Dell ExpressSign-in detects your presence when you're close and uses Windows Hello to log you in. When you walk away, it locks your PC for increased security.



Product availability may vary by region and product features may vary by model; please refer to [Dell.com](https://www.dell.com) for more details.

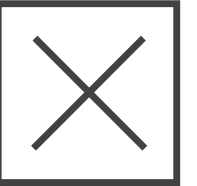

Tailor your presentation with adjustable Field of View (FOV)

Position the tilt adjustable camera (0-20°) to the angle you want and customize how much you want to show of your surroundings by adjusting your field of view to 65°, 78°, 90°. Get closer to your audience than ever before with up to 5X digital zoom.



65° FOV

Best for face-to-face conversations

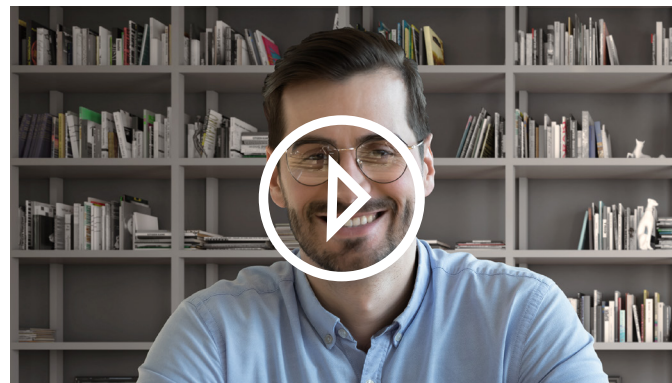

78° FOV

Keeps you as the main focal point of the scene while providing more context for your location.



90° FOV

Wide angle, ideal for showing objects or whiteboard content

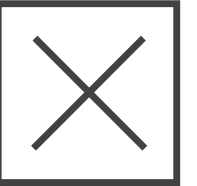

Protect your webcam lens, and your privacy

A magnetic shutter cap allows you to effortlessly cover the webcam's lens for privacy and protecting it when not in use. When it's time for a call, the cap can be conveniently stowed behind the webcam.





WEBCAM

Certified for
Microsoft Teams

zoom Certified



Certified for
Microsoft Teams

zoom Certified



Certified for
Microsoft Teams

zoom Certified



Dell UltraSharp Webcam - WB7022

Experience best image quality in its class with the world's most intelligent 4K webcam.*



[Read More](#)

Dell Pro Webcam - WB5023

Professional 2K QHD webcam with advanced image processing technology to optimize performance



[Read More](#)

Dell Webcam - WB3023

Essential 2K QHD webcam for everyday use



[Read More](#)

Product availability may vary by country, please refer to the product page on Dell.com for more information.

*Based on internal analysis of external 4K personal conferencing webcams, April 2021.

The CES Innovation Awards are based upon descriptive materials submitted to the judges.

CTA did not verify the accuracy of any submission or of any claims made and did not test the item to which the award was given.



[Specifications summary](#)



WEBCAM COMPARISON



Dell UltraSharp Webcam - WB7022

World's most intelligent 4K webcam¹ with the best image quality in its class



Dell Pro Webcam - WB5023

Professional 2K QHD webcam with advanced image processing technology to optimize performance



Dell Webcam - WB3023

Essential 2K QHD webcam for everyday use

Resolution	4K UHD	2K QHD	2K QHD
Sensor	Large Sony STARVIS™ CMOS sensor	Large Sony STARVIS™ sensor	Sony image sensor
Field of View (FOV)	65°, 78°, 90°	65°, 78°	65°, 78°
HD Digital Zoom / Autofocus	Up to 5x / Yes	Up to 4x / Yes	Up to 2x / Yes
Noise Reduction Mic	Not included	Yes ²	Yes ²
Auto-Light Correction	Advanced Digital Overlap HDR (DOL-HDR) Temporal (3D) Noise Reduction Spatial (2D) Noise Reduction	Advanced Digital Overlap HDR (DOL-HDR) Temporal (3D) Noise Reduction Spatial (2D) Noise Reduction	High Dynamic Range (HDR) Temporal (3D) Noise Reduction Spatial (2D) Noise Reduction
Auto White Balance	Yes	Yes	Yes
Facial Detection Auto Exposure	Yes	Yes	Yes
AI Auto Framing	Yes	Yes	No
Operating System Support	Win11/10 64 Bit & Mac OS	Win11/10 64 Bit & Mac OS	Win11/10 64 Bit & Mac OS
Software	Dell Peripheral Manager (Windows OS) Dell Display and Peripheral Manager (Mac OS)	Dell Peripheral Manager (Windows OS) Dell Display and Peripheral Manager (Mac OS)	Dell Peripheral Manager (Windows OS) Dell Display and Peripheral Manager (Mac OS)
Certification	Microsoft Teams, Zoom; Compatible with leading UC platforms	Microsoft Teams, Zoom; Compatible with leading UC platforms	Microsoft Teams, Zoom; Compatible with leading UC platforms
Others	Windows Hello sign in Dell ExpressSign-in		

Product availability may vary by country, please refer to the product page on Dell.com for more information.

¹ Based on internal analysis of external 4K personal conferencing webcams, April 2021.

² Please enable the microphone on the Dell Peripheral Manager for Windows or Dell Display and Peripheral Manager for Mac OS application.





HEADSETS



Dell Premier Wireless ANC Headset - WL7022

Premium wireless headset offers an immersive audio experience with active noise cancellation (ANC) feature.



[Read More](#)



Dell Pro Wireless Headset - WL5022

Wireless headset that offers convenient call controls and exceptional audio clarity on the go.



[Read More](#)



Dell Pro Stereo Headset - WH3022

Wired headset with high quality stereo sound and built-in noise cancellation feature.



[Read More](#)



Dell Stereo Headset - WH1022

Wired headset that offers a comfortable, reliable and distraction-free experience.

















[Read More](#)



[Specifications summary](#)



HEADSET COMPARISON

Headsets	   	   	   	 
Noise Cancellation (output)	Active Noise Canceling (ANC)	Passive	Passive	Passive
Microphone type	1x adjustable boom mic (can be worn on the left or right), 2x MEMS	1x adjustable boom mic (can be worn on the left or right), 1x MEMS	1x boom mic (can be worn on the left or right)	Bi-directional rotatable Mic (can be worn on the left or right)
Battery Capacity / Battery Life	325 mAh / 2.5 hours to full charge	360 mAh / 1.5 hours to full charge	Not Included (Corded)	Not Included (Corded)
Connectivity	PC via USB (type A); Mobile devices via Bluetooth	PC via USB (type A); Mobile devices via Bluetooth	PC via USB (type A)	PC via USB (type A) or 3.5mm stereo jack
Wireless range	Up to 30m (98ft.) with USB adapter	Up to 30m (98ft.) with USB adapter	Not Included (Corded)	Not Included (Corded)
Weight	155 grams	150 grams	96 grams	121 grams
Headband and Earpad	Adjustable leatherette headband and earpads	Adjustable leatherette headband and earpads	Adjustable headband and ear cushions	Lightweight, padded and adjustable headband
Certification	Microsoft Teams, & Zoom certified ; Compatible with leading UC platforms	Microsoft Teams, & Zoom certified ; Compatible with leading UC platforms	Microsoft Teams, & Zoom certified ; Compatible with leading UC platforms	Not Included
Call control	Dedicated mute button Dedicated Microsoft Teams button	Dedicated mute button	Call control buttons available on control panel - Call, volume up and down, mute	Call control buttons available on control panel - Call, volume up and down, mute
Others	Smart sensors that automatically mute and unmute calls			





SOUNDBARS



Dell Slim Conferencing Soundbar - SB522A

Experience clear conferencing and reduced background noise with the world's most intelligent Microsoft Teams-certified soundbar¹.



[Read More](#)



Dell Slim Soundbar - SB521A

World's slimmest and lightest soundbar² offers exceptional audio clarity and magnetically attaches to Dell monitors³.

[Read More](#)

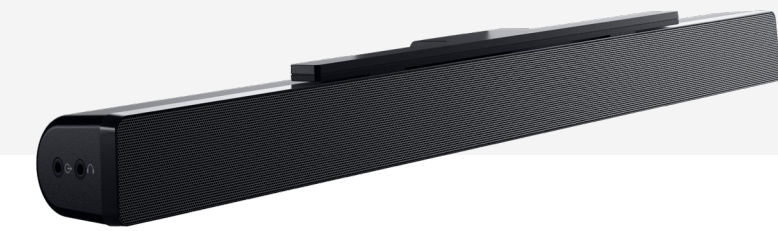

Dell Stereo Soundbar - AC511M

Experience clear stereo sound and enjoy great audio on your favorite games, music and movies, without sacrificing desk space.

[Read More](#)

Product availability may vary by country, please refer to the product page on Dell.com for more information.
¹ 'Most intelligent' based on the Dell Slim Conferencing Soundbar being the only Microsoft Teams certified soundbar with AI noise-cancellation. Based on comparative analysis of Microsoft Teams-certified soundbars – August, 2021.
² Based on Dell analysis of publicly available specs of comparative attachable monitor soundbars, July 2020.
³ Compatible with select Dell monitors only.



[Specifications summary](#)



SOUNDBAR COMPARISON



Dell Slim Conferencing Soundbar
- SB522A



Dell Slim Soundbar
- SB521A



Dell Stereo Soundbar
- AC511M

Soundbars	Dell Slim Conferencing Soundbar - SB522A	Dell Slim Soundbar - SB521A	Dell Stereo Soundbar - AC511M
Frequency Response	180 Hz - 20 KHz	180Hz - 20kHz	100Hz to 20kHz
Audio performance	AI Noise Cancellation, Echo Cancellation, Full Duplex Audio, 2.0 Stereo	2.0 Stereo	2.0 stereo
Continuous Power	4.5 Watt RMS speaker	3.6 Watt RMS peaker	2.5 Watt RMS speaker
Integrated microphone	Yes	No	No
Integrated controls	Yes and with dedicated Microsoft Teams button	No	No
Monitor attachment method	Magnetic	Magnetic	Soundbar mount
Connection type	USB-A	USB-A	USB-A, 3.5mm headphone jack, 3.5mm aux-in port
Certification	Microsoft Teams & Zoom certified Compatible with leading UC platforms	Not Included	Not Included
Dell Peripheral Manager support (Windows only)	Yes	Not Included	Not Included
Compatible monitors	Read More	Read More	Read More



SPEAKERPHONES



Dell Speakerphone with Multiport Adapter - MH3021P

Enjoy an all-in-one conference and connectivity solution with the world's first speakerphone with an integrated USB-C multiport adapter¹.



[Read More](#)

Product availability may vary by country, please refer to the product page on Dell.com for more information. The CES Innovation Awards are based upon descriptive materials submitted to the judges. CTA did not verify the accuracy of any submission or of any claims made and did not test the item to which the award was given. ¹ Based on Dell analysis, March 2020. ² Based on Dell analysis comparing against competitive personal conferencing speakerphones, September 2021.

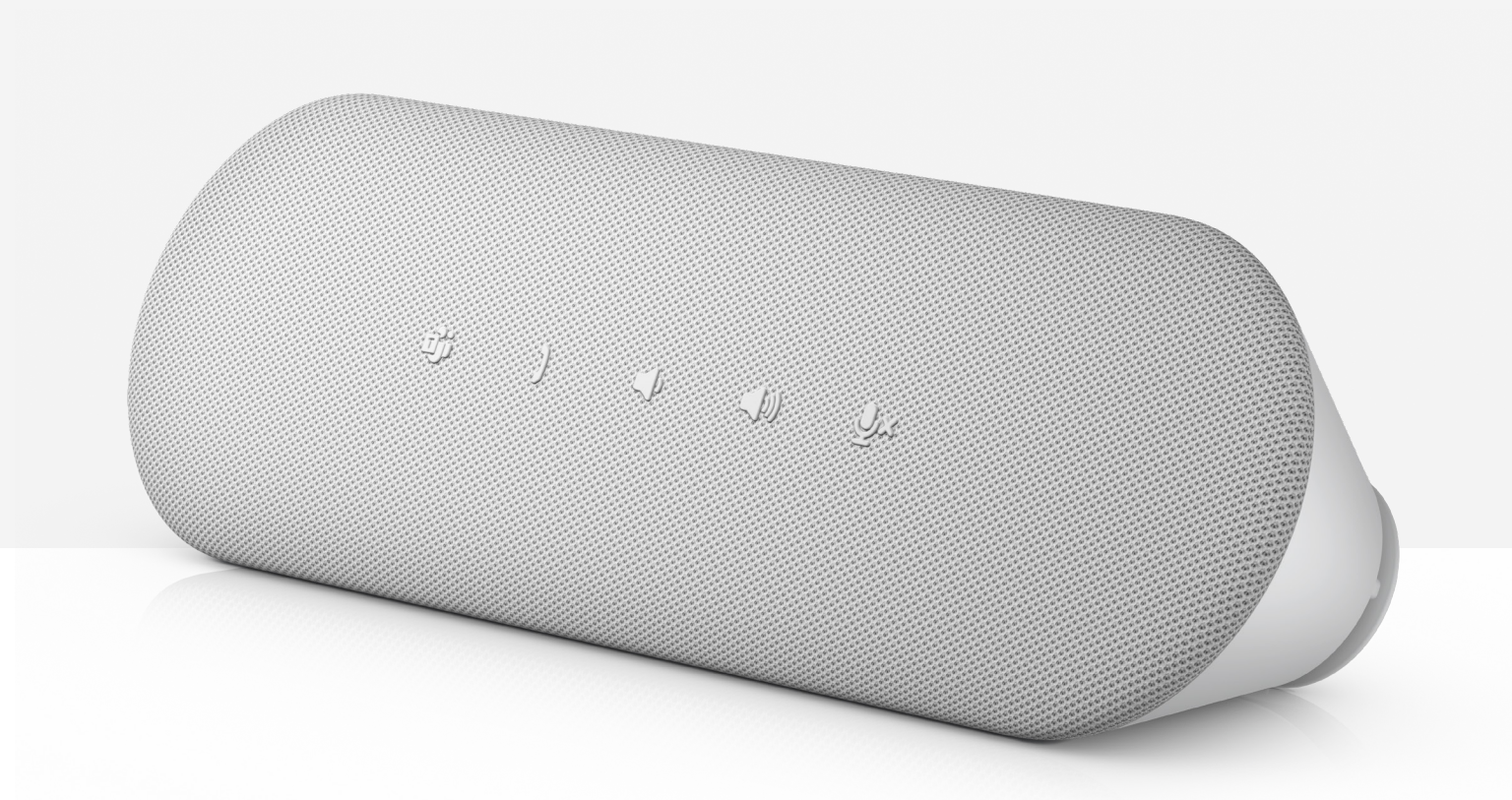

Dell Speakerphone - SP3022

Experience crystal-clear conference calls with the world's most intelligent² Microsoft Teams-certified speakerphone with full duplex audio and AI Noise Cancellation.



[Read More](#)

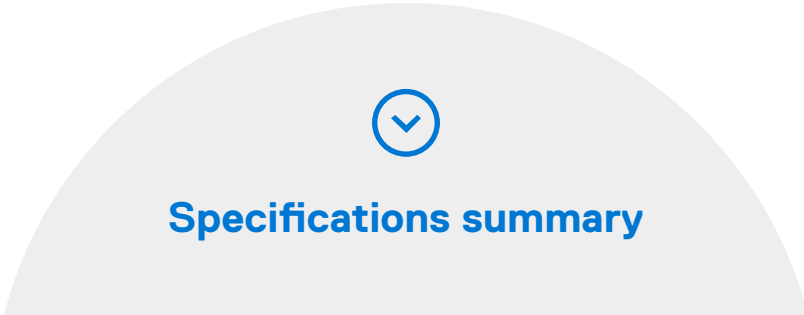



SPEAKERPHONE COMPARISON



Dell Speakerphone with Multiport Adapter - MH3021P

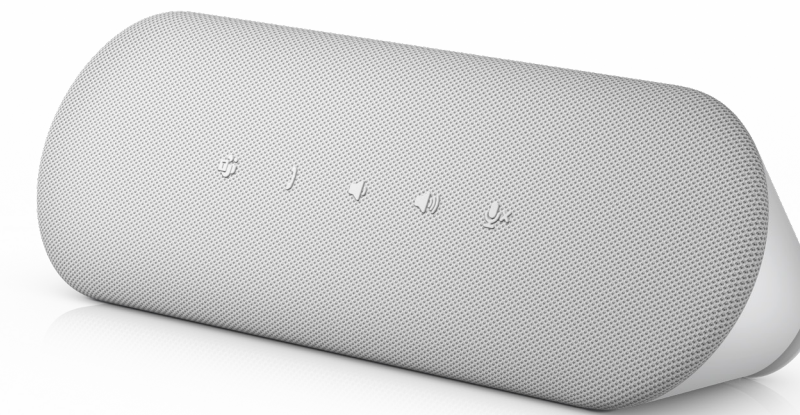

Dell Speakerphone - SP3022



Speakerphones	Dell Speakerphone with Multiport Adapter - MH3021P	Dell Speakerphone - SP3022
Audio performance	Echo cancellation and noise reduction	AI noise cancellation, full duplex audio, echo cancellation
Audio Frequency Response	200Hz – 20kHz	90Hz-20KHz
Microphone type	Omnidirectional microphone	Omnidirectional microphone
Microphone Frequency	100Hz – 10kHz	120Hz-7000Hz
Connection type	USB-C	USB-A with integrated USB-C adapter
Weight	214 grams	327 grams
Certification	Zoom certified ; Compatible with leading UC platforms	Microsoft Teams & Zoom certified ; Compatible with leading UC platforms
Dell Peripheral Manager support (Windows only)	N/A	Yes
Call control	Call, volume up and down, mute buttons	Dedicated Microsoft Teams button, call, volume up and down, mute buttons
Others	4 built-in ports ¹ : HDMI 2.0, USB-C, 2x USB-A Up to 4K resolution support for display ² Up to 10Gbps support for highspeed data transfer ³ Up to 90W power delivery for PC charging ⁴	

Product availability may vary by country, please refer to the product page on Dell.com for more information.

¹ Only one video output is supported at a time on a first come first served basis. If the HDMI and USB-C video are connected at the same time, HDMI will have priority.

² Available with select PC models (that support DisplayPort 1.4, HBR3) and when connected to displays that offer 4K resolution at 60Hz, with HDR support.

³ When adapter speakerphone draws power from the laptop: (a) and is connected to laptop's USB-C/Thunderbolt port (3A/5V) – 2 downstream USB-A and 1 USB-C port support selected devices (b) and is connected to laptop's USB-C/Thunderbolt port (1.5A/5V) – 2 downstream USB-A ports and 1 USB-C can support low power consumption devices such as mouse, keyboard, Bluetooth / RF dongle, selected thumb drives.

⁴ Up to 90W can be used to charge your USB-C laptop. Actual power supplied is dependent on your power source/platform power policy.





DELL PERIPHERAL MANAGER FOR WEBCAMS

Get the most from your webcam. With Dell Peripheral Manager you can personalize settings and activate intelligent features to optimize performance.*

Click for more details



LEARN MORE ABOUT DELL PERIPHERAL MANAGER

*Feature availability varies between devices and models.

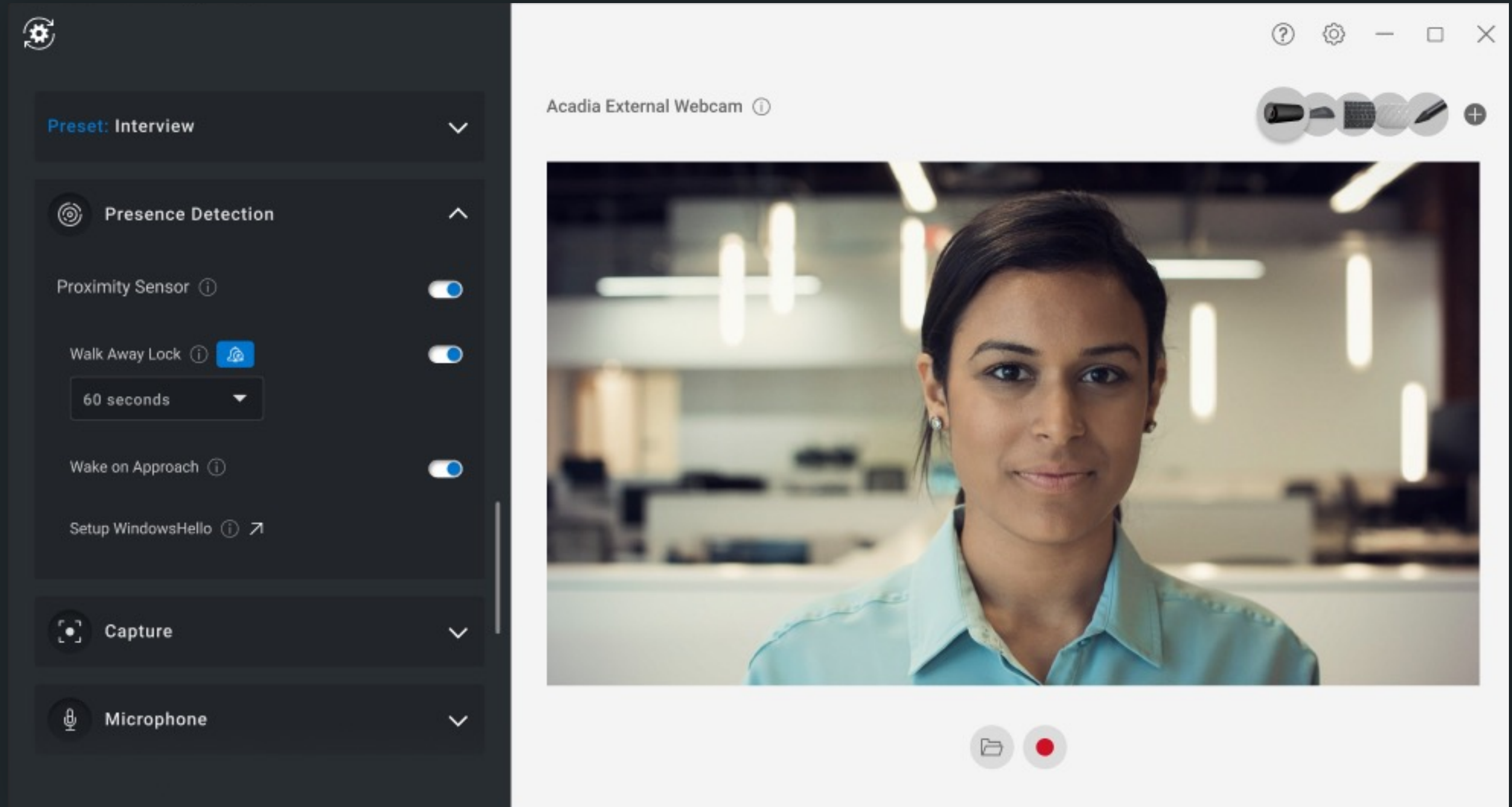



DELL PERIPHERAL MANAGER FOR WEBCAMS

Easily enable and customize the following features* and settings based on your preference.

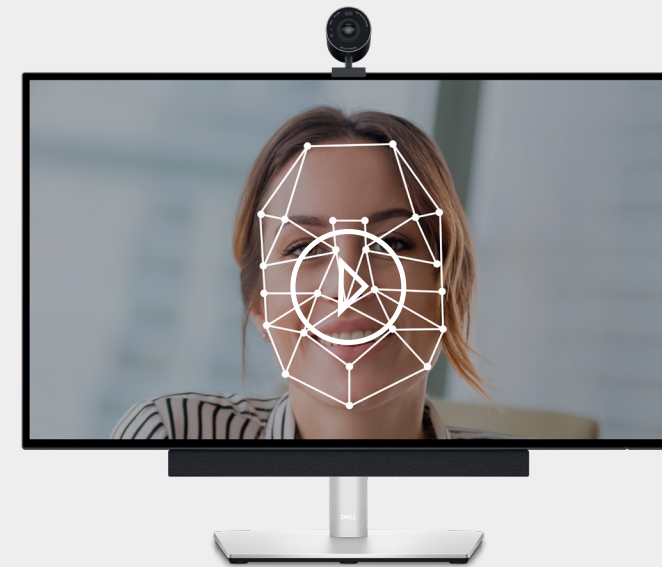

Get to work, fast

Enable proximity sensor that detects and allows you to sign-in to your device quickly with Windows Hello. Enable and customize walk away lock that keeps your PC secure by automatically locking your screen when you walk away.

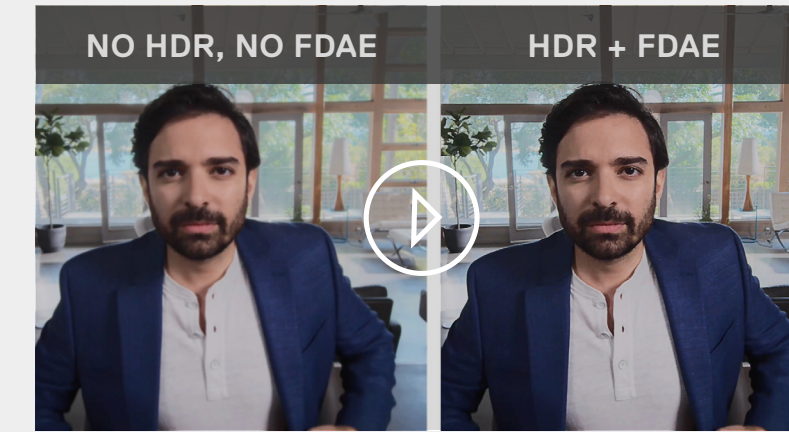

Look great, always

Enable HDR and Auto White Balance feature that will help deliver true-to-life colour in extreme lighting environment.



Keeping you in focus

Enable AI auto framing that help tracks your movement your movement and keeps you at the center of the picture, however you move. You can also control sensitivity, framing and speed of tracking.

Present your best

Customize how much you want to show of your surroundings by adjusting your **field of view**. Get closer to your audience than ever before with **digital zoom** and **auto focus**.

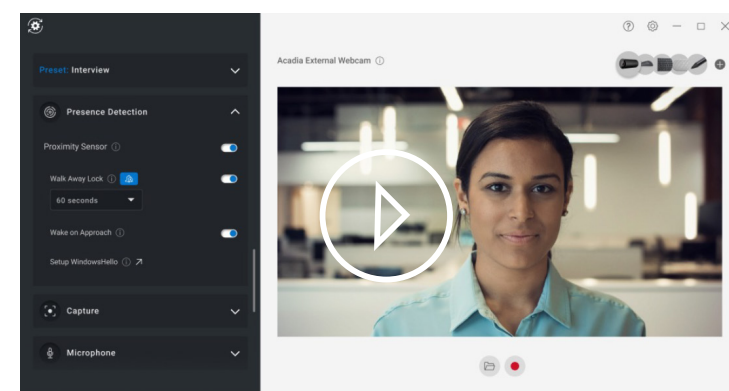

Enhanced experience

Select video presets as well as creating your own custom preset. Other customizable user settings include color adjustment, brightness, sharpness, contrast, resolution and frame rate.

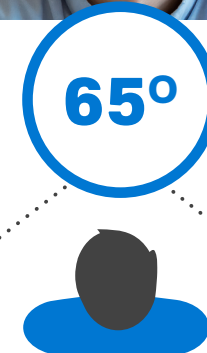

Best for face-to-face conversations

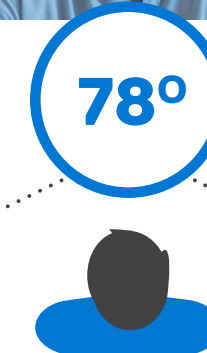
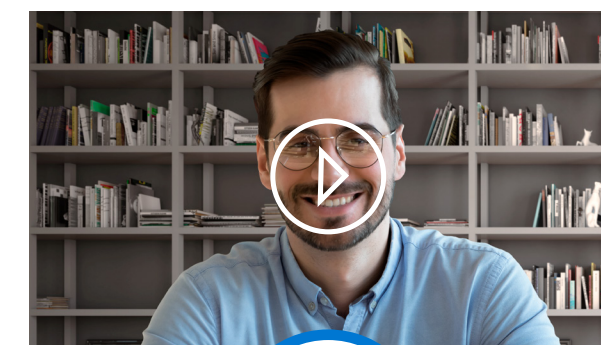

Keeps you as the main focal point of the scene while providing more context for your location.

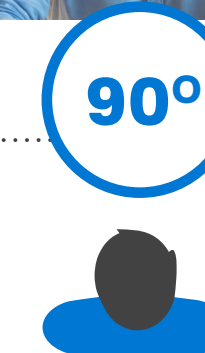

Wide-angle, ideal for showing objects or whiteboard content

*Product features may vary by model; please refer to Dell.com for more details.



DELL PERIPHERAL MANAGER FOR AUDIO DEVICES

Take your listening experience and privacy control to the next level with the latest easy-to-use equalizer settings and AI noise cancellation.

CUSTOMIZE HOW YOU LISTEN

Configure your audio using simple-to-use equalizer settings and manage background noise with intelligent noise cancellation. Advanced customization includes audio presets, sounds & notifications and product updates.

OPTIMIZE YOUR PRODUCTIVITY

Keep your devices up to date with the latest firmware, so your devices work efficiently.

[LEARN MORE ABOUT DELL PERIPHERAL MANAGER](#)

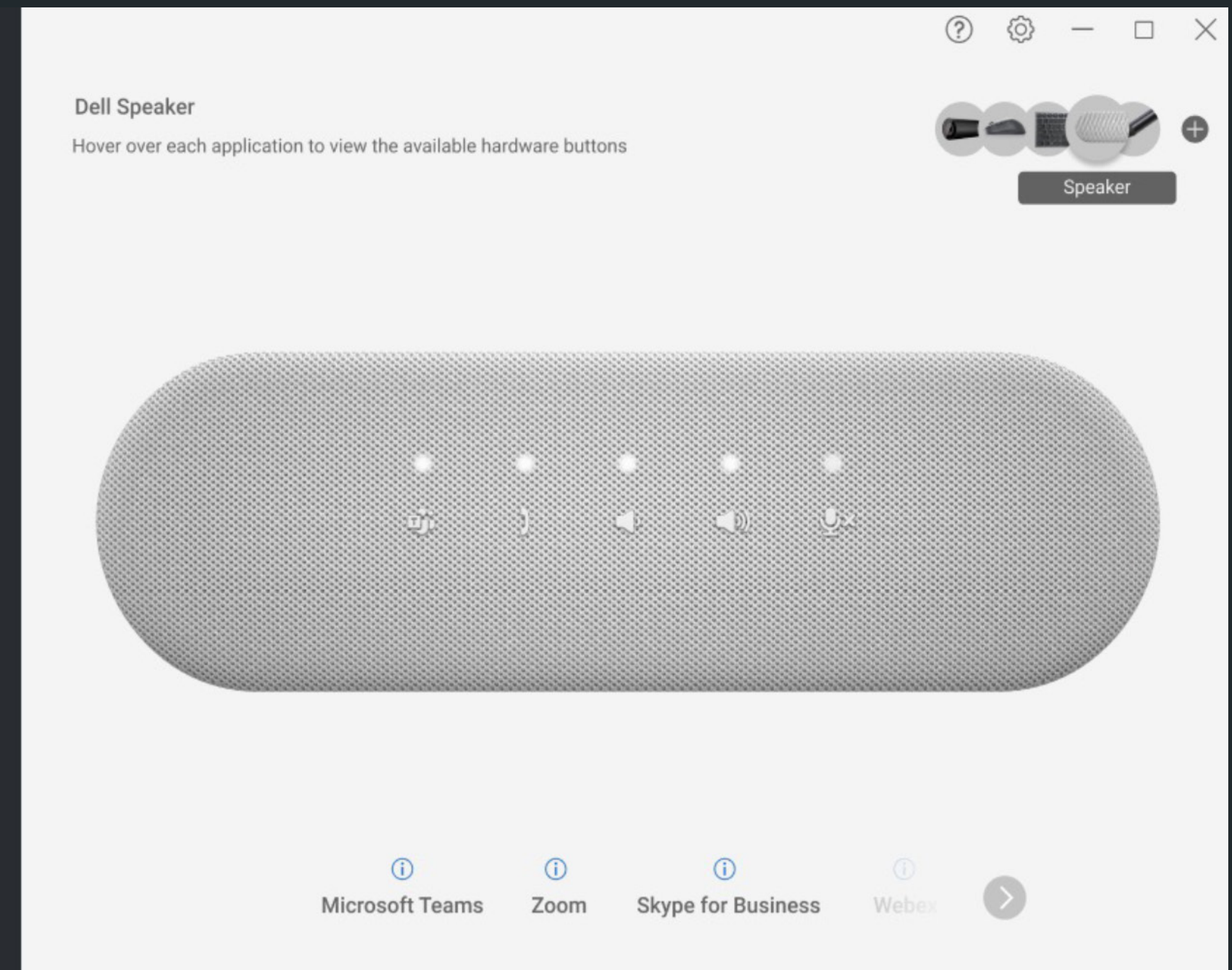
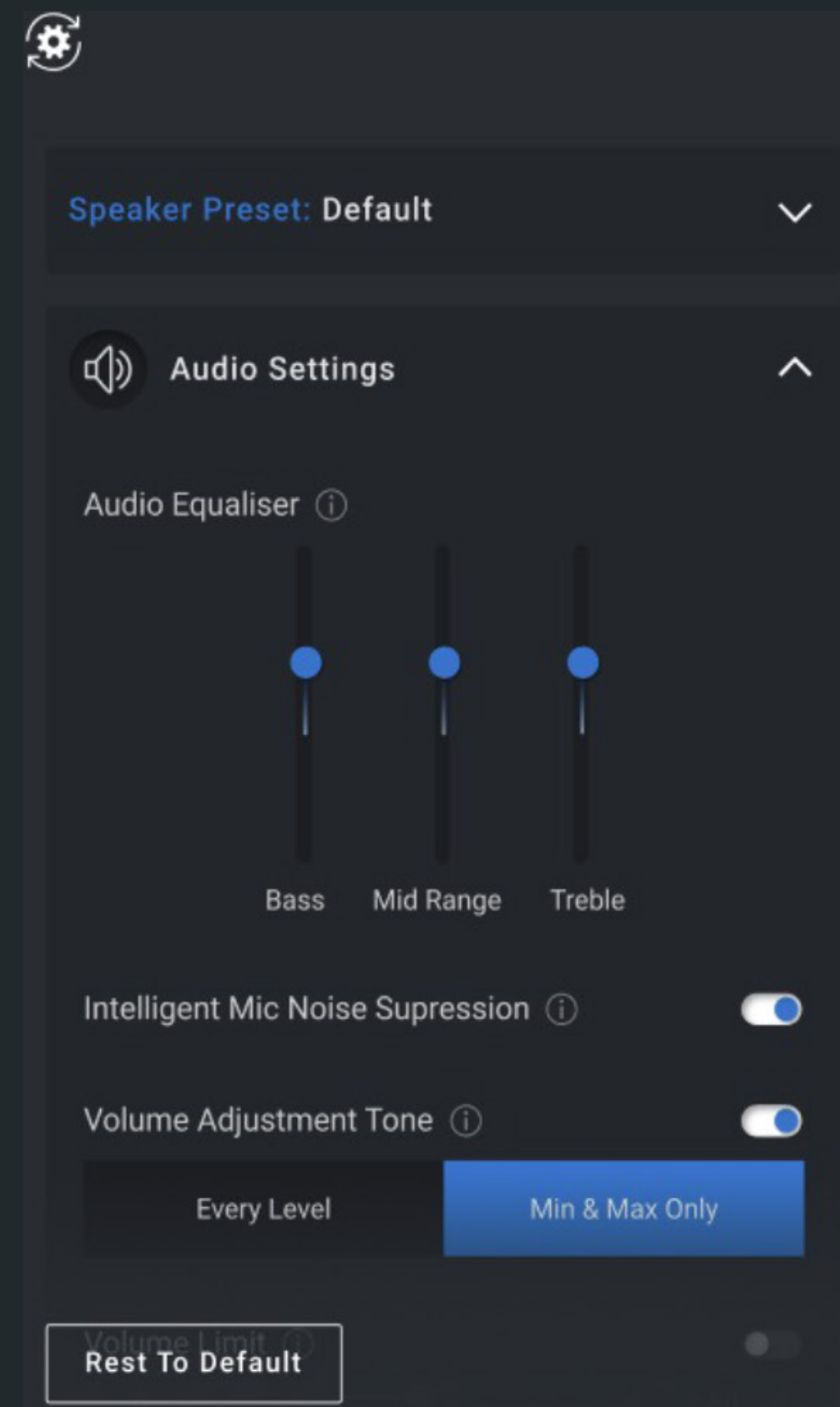

DELLTechnologies

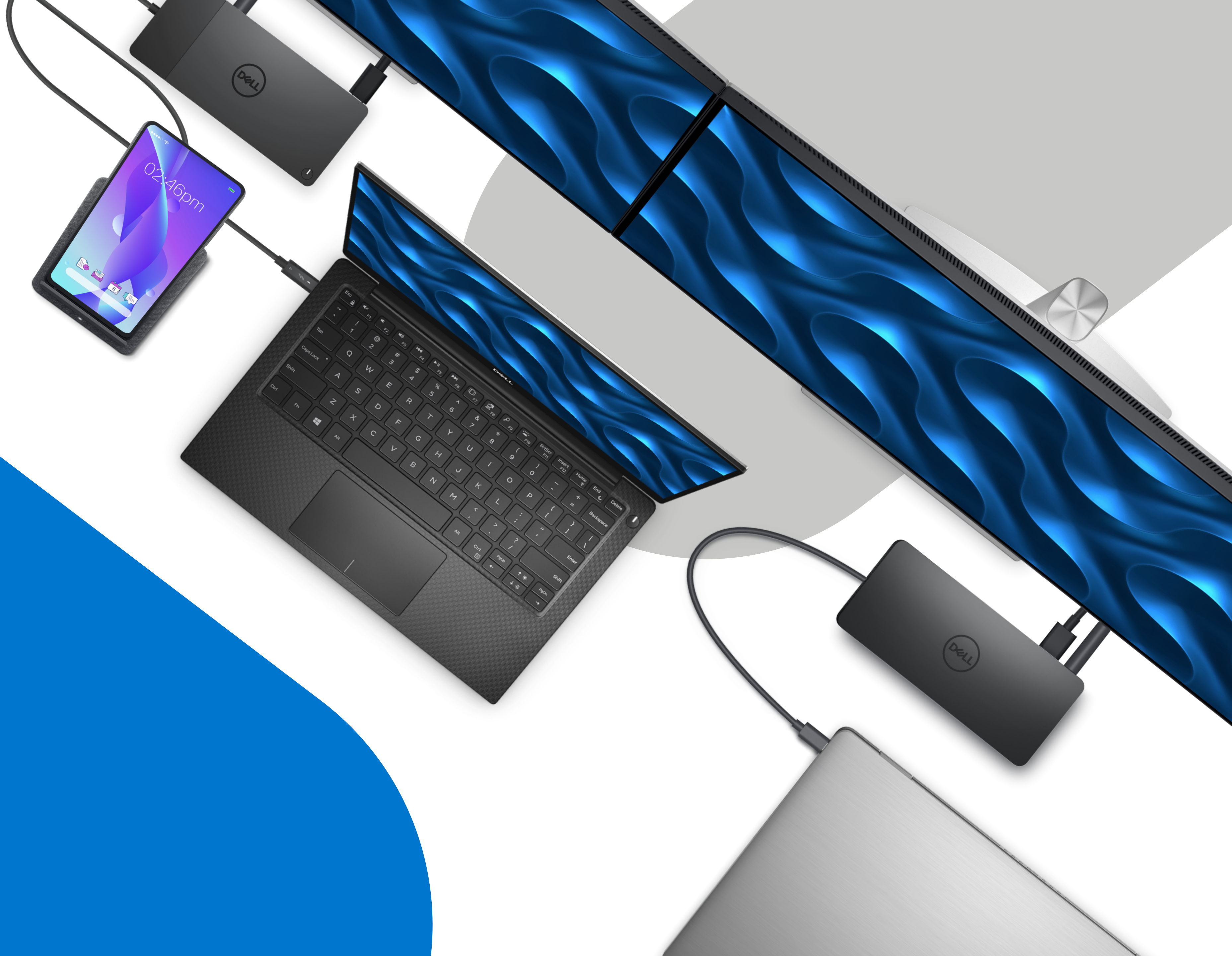

DELL DOCKS

FLEXIBILITY TO UPSCALE ACCORDING TO YOUR NEEDS

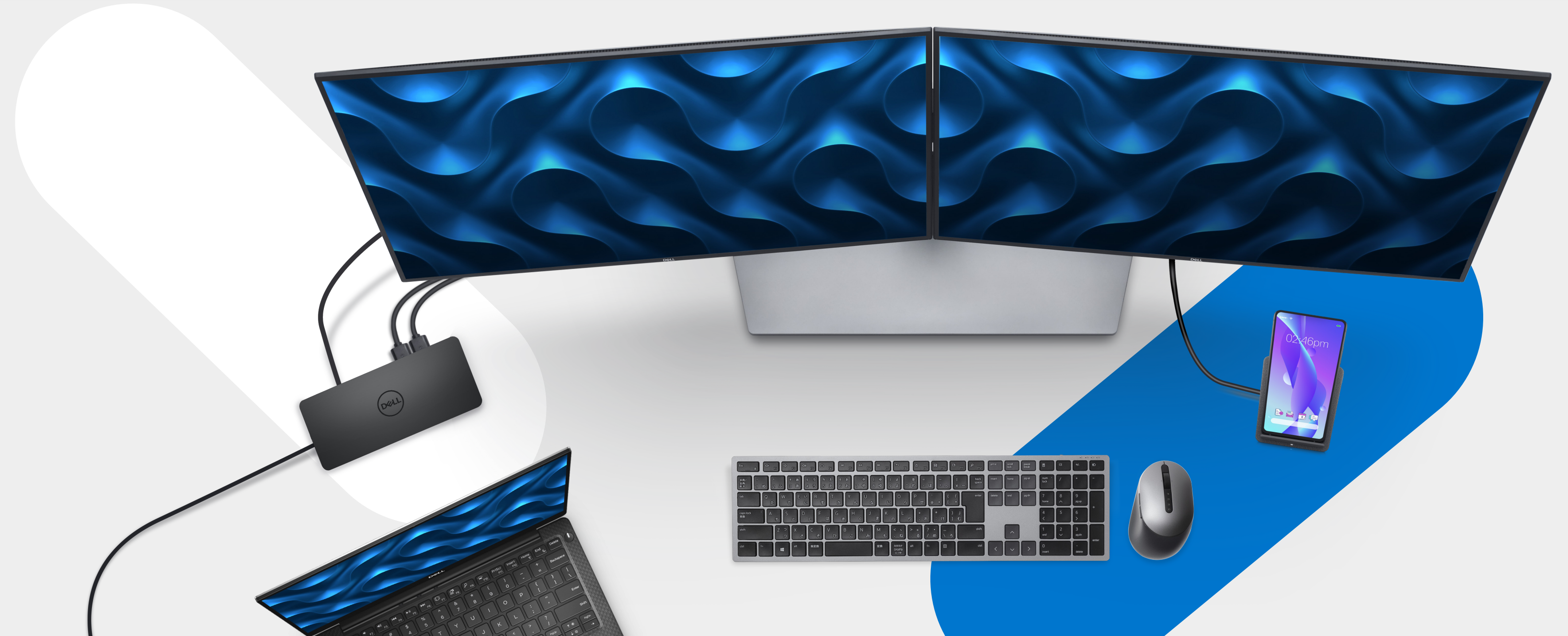

Upscale your workspace with a choice of devices that cater to your growing needs. Dell Docks offer the greatest compatibility across Dell laptops and are easy to deploy, manage and upgrade for added peace of mind.

Whether you're working from home, at the office or hotdesking, a Dell dock allows you to build customized and optimized workspaces with no compromise on power or performance.

When it's time to upgrade, our range of modular docks allows you to switch out your module to convert to Thunderbolt™ connectivity at a fraction of the cost.

Combined with streamlined management through a single firmware, and world-class Dell support and warranty, the latest docks represent a forward-looking investment to keep you powered and productive today and well into the future.

[Read More](#)



POWER PRODUCTIVITY WITH DELL DOCKS



FASTEST CHARGING

Increase your power delivery and charge faster with docks that deliver **up to 210W** of power. ExpressCharge allows for an **80%** charge on your PC's battery in one hour¹, while ExpressCharge Boost provides **35% charge in 20 minutes** on compatible systems².



ENHANCED PRODUCTIVITY

Enhance productivity with Dell's powerful docks and connect multiple monitors and accessories with a wide range of connectivity options.



FUTURE-READY DESIGN

Dell offers a line of docks that are the first in the world to feature a modular design letting you upgrade connectivity and power³ when you need it.

[Find out more about modular docks](#)

[Read More](#)



INTELLIGENT MANAGEMENT

Streamline the deployment and management of all the docks in the family with a single firmware, regardless of their connectivity. Perform firmware updates in minutes without needing to reboot the system.



SUPPORT

Dell Docks come with a 3-year Advanced Exchange Service.⁴ If a replacement becomes necessary, Dell will send a new dock the next business day during your Limited Hardware Warranty period.⁵

Product availability may vary by region and product features may vary by model; please refer to Dell.com for more details. ¹ Within Dell Power Manager software, selecting ExpressCharge™ can recharge system battery from 0% up to 80% within 60 minutes. After charging has reached 80% capacity, charging speed will return to normal speed. Recommended for use with the provided Dell power adapter; not recommended with a smaller capacity power adapter. Charging time may vary +/-10% due to system tolerance. ² Within Dell Power Manager software, selecting either the Default mode of Adaptive Charge or ExpressCharge™ can recharge system battery from 0% up to 35% within 20 minutes when system is powered-off and battery temperature is between 16-45 degrees C. With ExpressCharge™ mode enabled, the system battery can then continue charging up to 80% within 60 minutes. After charging has reached 80% capacity, charging speed will return to normal speed. Recommended for use with the provided Dell power adapter; not recommended with a smaller capacity power adapter. Charging time may vary +/-10% due to system tolerance. ³ Based on Dell internal analysis, February 2019. ⁴ Advanced Exchange Service: Dell will send you a replacement dock the next business day in most cases, if deemed necessary after phone/online diagnosis. Shipping times may vary by location. Fee charged for failure to return defective unit. See dell.com/servicecontracts/global. ⁵ 3-year Limited Hardware Warranty is extendable to 5 years with additional fee.



WHAT'S NEW

DELL DUAL CHARGE DOCK – HD22Q

Power your productivity with the world's first laptop docking station with a wireless charging stand for Qi-enabled smartphones and earbuds.¹

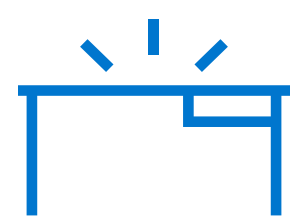

WORKSPACE FLEXIBILITY

Compact and innovative with centered cabling, this dock saves desk space, reduces cable clutter and integrates seamlessly into your home office.



CONVENIENT CHARGING

Charge your laptop, USB peripherals and Qi-enabled smartphone or earbuds simultaneously,¹ using the convenient upright stand. Continue to access the applications on your smartphone in landscape or portrait mode.

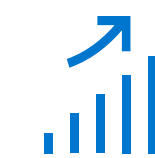

CONNECTED PRODUCTIVITY

Connect to multiple devices and displays with the latest ports for video and data. Get to work quickly with the Wake-on-Dock feature that wakes your laptop when you connect the dock using USB-C.

¹Within Dell Power Manager software, selecting ExpressCharge can recharge system battery from 0% up to 80% within 60 minutes. After charging has reached 80% capacity, charging speed will return to normal speed. Recommended for use with the provided Dell power adapter; not recommended with a smaller capacity power adapter. Charging time may vary +/-10% due to system tolerance.



WHAT'S NEW

DELL THUNDERBOLT™ DOCK – WD22TB4

Boost your PC's power on the world's first modular Thunderbolt™ 4 dock¹ with a future-ready design.

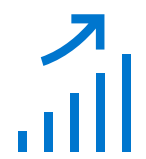

ENHANCED PRODUCTIVITY

Dell ExpressCharge allows you to charge up to 80% in one hour². Increase your power delivery and charge faster with a dock that delivers up to 130W of power.



FUTURE-READY DESIGN

Get the latest in connectivity with two Thunderbolt™ 4 ports for even more flexibility.



INTELLIGENT MANAGEMENT

Streamline the deployment and management of Dell docks with a single firmware, regardless of their connectivity. Perform firmware updates in minutes without needing to reboot the system.

¹World's first modular Thunderbolt™ 4 dock - based on Dell analysis, Nov 2021. ² Within Dell Power Manager software, selecting ExpressCharge™ can recharge system battery from 0% up to 80% within 60 minutes. After charging has reached 80% capacity, charging speed will return to normal speed. Recommended for use with the provided Dell power adapter; not recommended with a smaller capacity power adapter. Charging time may vary +/-10% due to system tolerance.

WHAT'S NEW

DELL UNIVERSAL DOCK – UD22

Build the workspace that works for you with the ultimate universal dock for any USB-C laptop, featuring fast charging, the highest number of ports¹ and the ability to support the highest number of displays.¹

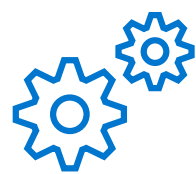

CONSISTENTLY SEAMLESS EXPERIENCE

Connect to any USB-C laptop and run any operating system regardless of the manufacturer. Achieve a fast-charging experience with 96W power delivery for all laptops.

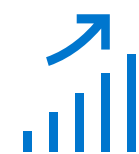

UNCOMPROMISED PRODUCTIVITY

Maximize productivity with the ability to connect four 4K displays at one time. Create a productive and flexible environment with the highest number of ports on any universal dock¹, with 4 x USB-A ports, 2 x USB-C ports and 4 video ports.



INTELLIGENT MANAGEMENT

Connect your laptop and get started quickly even when the DisplayLink driver is not installed, thanks to the additional support for Hybrid DP Alt mode.

¹ Based on internal analysis of competitive products, using publicly available data - December 2021

FOR HOME OFFICE DESKS



Dell Dual Charge Dock - HD22Q

Powerfully productive, this compact dock is the world's first laptop docking station with a wireless charging stand for Qi-enabled smartphones or earbuds.¹

[Read More](#)

¹ Within Dell Power Manager software, selecting ExpressCharge can recharge system battery from 0% up to 80% within 60 minutes. After charging has reached 80% capacity, charging speed will return to normal speed. Recommended for use with the provided Dell power adapter; not recommended with a smaller capacity power adapter. Charging time may vary +/-10% due to system tolerance.

[Specifications summary](#)



FOR OFFICE DESKS



Upgrade your connectivity and boost your power delivery with the world's first modular docks.¹ Scale up to the evolving demands of your PC environment, while significantly reducing upgrade costs.



Upgrade easily and reduce e-waste by switching out modules, rather than replacing entire docks.



Dell Thunderbolt™ Dock - WD22TB4

World's first modular Thunderbolt™ dock² with swappable modules for easy upgrades and ExpressCharge technologies for fast charging. [Certified for Apple® USB-C host.](#)



[Read More](#)



Dell Performance Dock - WD19DCS

Boost your PC's power up to 210W on the world's first and most powerful modular Dual USB-C dock³ with a future-ready design.



[Read More](#)



Dell Dock - WD19S (130/180)

Boost your PC's power up to 130W (via WD19S 180) / up to 90W (via WD19S 130) with ExpressCharge on the world's most powerful USB-C® dock.⁵



[WD19S 130](#)







[WD19S 180](#)

Product availability may vary by region and product features may vary by model; please refer to Dell.com for more details. ¹ Based on Dell internal analysis, February 2019. ² World's first modular Thunderbolt™ 4 dock - based on Dell analysis, Nov 2021. ³ Based on Dell internal analysis of competitive products using publicly available data as of February 2019. Power Delivery of up to 210W when used with compatible Dell systems. ⁴ Based on Dell internal analysis of competitive products using publicly available data as of February 2019. Power Delivery of up to 130W when used with compatible Dell systems. ExpressCharge Boost is available on select Dell systems. ⁵ Based on Dell internal analysis of competitive products using publicly available data as of February 2019. Power Delivery of up to 130W (via WD19S 180) / up to 90W (via WD19S 130) when used with compatible Dell systems.



[Specifications summary](#)

TECHNICAL SPECIFICATIONS COMPARISON

	 Dell Dual Charge Dock - HD22Q	 Dell Thunderbolt™ Dock - WD22TB4	 Dell Performance Dock - WD19DCS	 Dell Dock - WD19S 130w	 Dell Dock - WD19S 180w	 Dell Universal Dock - UD22
HBR2 PC¹	For a HBR2 PC 2 x FHD @ 60Hz 1 x 4K @ 30Hz	For a HBR2 PC (If the laptop has Thunderbolt functionality) 3 x FHD @ 60Hz 3 x QHD @ 60Hz 2 x 4K @ 60Hz	For a HBR2 PC (If the laptop has dual USB-C docking support) 3 x FHD @ 60Hz 3 x QHD @ 60Hz 1 x 4K @ 60Hz	For a HBR2 PC 2 x FHD @ 60Hz 1 x QHD @ 60Hz 1 x 4K @ 30Hz	For a HBR2 PC 2 x FHD @ 60Hz 1 x QHD @ 60Hz 1 x 4K @ 30Hz	For a HBR2 PC (If PC has DisplayLink driver setup) 2 x 4K @ 60Hz + 2 x FHD @ 60Hz 2 x 4K @ 60Hz + 1 x 4K @ 30Hz
HBR3 PC	For a HBR3 PC 2 x QHD @ 60Hz 1 x 4K @ 30Hz For HBR3 PC supporting Display Stream Compression 2 x 4K @ 60Hz 1 x 8K @ 30Hz	For a HBR3 PC 4 x FHD @ 60Hz, 4 x QHD @ 60Hz, 2 x 4K @ 60Hz For HBR3 PC supporting Display Stream Compression 4 x 4K 60Hz	For a HBR3 PC 3 x FHD @ 60Hz, 3 x QHD @ 60Hz, 2 x 4K @ 60Hz For HBR3 PC supporting Display Stream Compression 3 x 4K @ 60Hz	For a HBR3 PC 3 x FHD @ 60Hz, 2 x QHD @ 60Hz, 1 x 4K @ 60Hz For HBR3 PC supporting Display Stream Compression 3 x QHD @ 60Hz, 2 x 4K @ 60Hz	For a HBR3 PC 3 x FHD @ 60Hz, 2 x QHD @ 60Hz, 1 x 4K @ 60Hz For HBR3 PC supporting Display Stream Compression 3 x QHD @ 60Hz, 2 x 4K @ 60Hz	For a HBR3 PC 2 x 4K @ 60Hz + 2 x QHD @ 60Hz 2 x 4K @ 60Hz + 1 x 4K @ 30Hz For HBR3 PC (supporting Display Stream Compression) 4 x 4K @ 60Hz
Video interfaces	1 x DP1.4 1 x HDMI 2.1	2 x Full size DP1.4 HDMI 2.0 USB-C Multi-function DisplayPort) Thunderbolt™ 4 USB-C	2 x Full size DP1.4 1 x HDMI 2.0 1 x MFDP USB-C	2 x Full size DP1.4 1 x HDMI 2.0 1 x MFDP USB-C	2 x Full size DP1.4 1 x HDMI 2.0 1 x MFDP USB-C	1 x HDMI 2.0 2 x DP 1.2 1 x USB-C Multi-function with DisplayPort 1.4
Ports	USB-A: 4 x USB 3.2 Gen 1 USB-C: 1 x USB 3.2 Gen 2 with Power Delivery 3.0 1 x RJ45	3 x USB 3.2 Gen 1 (1 with PowerShare) 2 x USB 3.2 Gen 2 (1 with DisplayPort 1.4 Alt Mode) 1 x RJ45	3 x USB-A 3.1 Gen 1 2 x USB-C 3.1 Gen 2 1 x RJ45	3 x USB-A 3.1 Gen 1 2 x USB-C 3.1 Gen 2 1 x RJ45	3 x USB-A 3.1 Gen 1 2 x USB-C 3.1 Gen 2 1 x RJ45	USB-A: 4 x USB 3.2 Gen 2 (1 with PowerShare) USB-C: 1 x USB 3.2 Gen 2 with PowerShare; 1 x USB 3.2 Gen 2 with DisplayPort 1.4 Alt Mode; 1 x RJ45
Power	Power Adapter 130 Watt AC with up to 90 Watt power delivery to USB-C Notebooks	Power Adapter 180 Watt AC with up to 130 Watt power delivery to Dell Commercial Laptops. Up to 90 Watts power delivery to non-Dell systems.	Includes a 240W power adapter and delivers up to 210W of power to compatible Dell PCs via dual connectors. Delivers 130W of power to Dell PCs and up to 90W to non-Dell PCs via a single connector.	Power Adapter 130 Watt AC with up to 90 Watts power delivery. Up to 90 Watts power delivery to non-Dell systems.	Power Adapter 180 Watt AC with up to 130 Watts power delivery. Up to 90 Watts power delivery to non-Dell systems.	Power Adapter 130 Watt AC with up to 96 Watt power delivery to any USB-C Notebook.
Docking Interface	Type-C Connector	Thunderbolt™ 4 (Type-C Connector)	Separable Dual DisplayPort over USB-C	USB-C	USB-C	Type-C Connector
Cable length	0.8 m	0.8m	0.8m	1.0m	1.0m	0.8m
	Docking compatibility	Docking compatibility	Docking compatibility	Docking compatibility	Docking compatibility	Docking compatibility

¹ HBR (High Bit Rate) is a DisplayPort standard which determines the bandwidth available for displays.
² Based on internal analysis of competitive products, using publicly available data - December 2021.

FOR SHARED WORKSPACES



Dell Universal Dock - UD22

The ultimate universal dock for any USB-C laptop, regardless of the operating system and manufacturer. With fast charging, support for multiple displays¹, and the highest number of ports¹ it allows you to build your workspace the way you like it.



[Read More](#)













¹Based on internal analysis of competitive products, using publicly available data - December 2021.



[Specifications summary](#)



FEATURES

FEATURE	WHY IT MATTERS
 PXE Boot	Allows for your PC to be imaged from a server on the network.
 Wake-On-LAN	Allows IT administrators to wake a PC remotely using a signal when the PC is on the corporate network.
 MAC Address Pass-Through	Allows IT administrators to uniquely identify PCs on a corporate network with a system-unique MAC (media access control) address in the system BIOS replacing the MAC address of the device. MAC Address Pass-Through not available with non-Dell systems.
 Port Disablement	Allows IT administrators to configure the system BIOS to disable downstream ports on the device to keep confidential information secure.
 Dell ExpressCharge™	Provides up to 80% battery charge in just one hour.
 Power Delivery up to 90W	Single cable offers data, audio, video and power to Latitudes and XPS laptops – up to 90W.
 Power Delivery up to 210W	Single cable offers data, audio, video and power to Precision, Latitudes and XPS laptops – up to 210W.
 Wake-On-Plug	Automatically turns on your laptop – that is powered down or on standby – and connects to the peripherals attached when you connect the USB-C cable to your laptop.
 Power button sync	Power up / wake up the laptop and monitor by pressing the power button on the dock. Applicable with select Dell notebook computers only.
 Dell Performance Mode	Allows select Dell Precision Mobile Workstations to provide native graphics output from discrete GPUs for up to 8K resolution or three 4K external displays while simultaneously providing 10 Gbps of USB data through a single cable.
 Remote firmware updates	Deploy firmware updates remotely with existing tools like SCCM or use Dell Command Update to automatically check for the latest BIOS, firmware or drivers required for the dock and PC.
 Error messages and dock event notifications	Dell Power Manager helps users understand when the power adapter connected to the dock is not capable of providing enough power to both the laptop and the dock.

DELL
ADAPTERS &
POWERBANKS





ADAPTERS



Simplify connectivity with Dell adapters, whether you're at home, in the office or on the go.



Extensive connectivity

Compatible with a broad range of operating systems, and featuring a wide array of ports available, Dell adapters offer seamless connectivity to various devices and accessories.



Reliability

Dell adapters undergo rigorous testing and work seamlessly with Dell systems. Enjoy peace of mind with Dell's renowned warranty and support services.



Thoughtfully designed

Stay productive wherever you are with compact and portable Dell adapters, designed to travel with you.



ADAPTERS



MULTIPOINT ADAPTERS

1. Dell 7-in-1 USB-C Multiport Adapter – DA310

Featuring a wide array of ports, the compact Dell 7-in-1 (DA310) or 6-in-1 (DA305) USB-C Multiport Adapter offers video, network, data connectivity and up to 90W power pass-through for your laptop. What's more, DA310 offers extensive enterprise level features such as MAC address pass-through, PXE Boot, Wake-OnLAN when used with Dell PCs.

[Read More](#)

2. Dell 6-in-1 USB-C Multiport Adapter – DA305



[Read More](#)

3. Dell Adapter USB-C to HDMI/DP with Power Pass-Through

Its USB-C pass-through allows you to charge your laptop up to 90W while connecting to an external 4K HDR display at 60Hz simultaneously without compromising on screen performance.

SINGLE ADAPTERS

Dell Single Function Adapters

Convert your connectivity ports with our wide range of USB-C or legacy connectivity adapters and enable connection to a wider range of computers and devices

[USB-C Adapters](#)

[Legacy Adapters](#)



[Specifications summary](#)



OVERVIEW

Multiport Adapters



Product Name	Dell 7-in-1 USB-C Multiport Adapter – DA310	Dell 6-in-1 USB-C Multiport Adapter – DA305	USB-C to HDMI/ Display Port
Ports	7	6	3
Downstream USB-C port	USB 3.2 Gen 2 (10Gbps), Display and Power pass-through	USB 3.2 Gen 2 (10Gbps), Display and Power pass-through	USB 3.2, Display and Power pass-through
USB-A	2 X USB-A 3.2 (10Gbps)	2 X USB-A 3.2 (10Gbps)	-
Ethernet (LAN)	1 Gbps	1 Gbps	-
DisplayPort	1.4, 4K@60Hz ¹	1.4, 4K@60Hz ¹	1.4, 4K@60Hz ¹
HDMI	2.0, 4K@60Hz ²	2.0, 4K@60Hz ²	2.0, 4K@60Hz ²
VGA	1920x1080 (1080p)	-	-
Power Pass-Through	Yes, up to 90W ³	Yes, up to 90W ³	Yes, up to 90W ³
Fast Role Swap Supportability	Yes	Yes	-
Enterprise Features	PXE Boot, Wake-On-LAN, MAC address	-	-
OS Support	Windows 10 (64bit) MacOS, Chrome, RHEL, Ubuntu	Windows 10 (64bit) MacOS, Chrome, RHEL, Ubuntu	Windows 10 (64bit) MacOS, Chrome
Dimensions (Diameter x Height) (mm)	69.8 x 24.5	69.8 x 24.5	65x 62
USB-C cable length (mm)	120	120	180
Weight (g)	80	84	63

¹ Available with select PC models (that support DisplayPort 1.2 and above) and when connected to displays that offer 4K resolution at 60Hz.
² Available with select PC models (that support DisplayPort 1.4 and above) and when connected to displays that offer 4K resolution at 60Hz, with HDR10 support.
³ Up to 90W can pass through the port to charge your USB-C laptop. Actual power supplied is dependent on your power source/ platform power policy.



OVERVIEW

Dell Single Function Adapters (USB-C)



Product Name	Dell Adapter - USB-C to VGA	Dell Adapter - USB-C to HDMI 2.0	Dell Adapter - USB-C to DP Adapter	Dell Adapter - USB-C to Ethernet Adapter (1Gbps)	Dell Adapter - USB-C to USB Type-A Adapter
Color	Black				
Interface	USB-C				
Connector A (Plug into notebook/ desktop)	USB-C (Male)				
Connector B (Interface to devices)	VGA (Female)	VGA (Female)	DP1.2 (Female)	Ethernet RJ-45 (Female)	USB Type-A (Female)
Supported OS	- All Windows - BIOS	- All Windows - BIOS	- All Windows - BIOS	- All Windows - BIOS	- All Windows - BIOS
Resolution	2048x1152 @ 60Hz	4096 x 2160 @ 60Hz	4096 x 2160 @ 60Hz	NA	NA



OVERVIEW

Dell Single Function Adapters (Legacy)



Product Name	Dell Adapter - DisplayPort to VGA	Dell Adapter - DisplayPort to HDMI2.0 (4K)	Dell Adapter - DisplayPort to DVI (Single-Link)	Dell Adapter - Mini DisplayPort to DisplayPort	Dell Adapter - HDMI to VGA	Dell Adapter - USB 3.0 to Ethernet
Color	Black					
Interface	DisplayPort			Mini DisplayPort	HDMI	USB 3.0
Connector A (Plug into notebook/desktop)	DisplayPort (Male)			Mini DisplayPort (Male)	HDMI (Male)	USB 3.0 A (Male)
Connector B (Interface to devices)	VGA (Female)	HDMI (Female)	DVI-D(Female)	DisplayPort (Female)	VGA (Female)	RJ45 (Female)
Supported OS	- All Windows and Linux. - BIOS.	- All Windows and Linux. - BIOS.	- All Windows and Linux. - BIOS.	- All Windows and Linux. - BIOS.	- All Windows and Linux. - BIOS.	- All Windows
Resolution	1920 x 1200 @ 60Hz	3840 x 2160 @ 60hz	1920x1200 @ 60hz	up to 2048x1536 75Hz	Up to 1080p 60 Hz	Up to 1Gbps

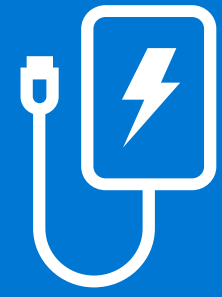

POWER BANKS



Keep your laptop and mobile devices powered and stay productive longer, wherever you are.



Power on the go

Get uninterrupted productivity while you're out and about, thanks to Dell power banks. Charge a wide range of laptops and mobile devices with up to 65W of power delivery.



Charging Convenience

Leave your smartphone charger at home and charge both your laptop and smartphone at the same time without having to worry about finding an additional wall socket to charge your devices.



Reliable

Get peace of mind with Dell's commitment to quality and reliability. Designed to industry specifications, Dell power banks are rigorously tested and certified to work perfectly with Dell laptops.

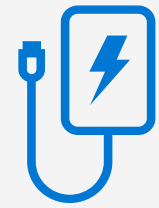

POWER BANKS



Dell Notebook Power Bank Plus **- USB C 65Wh - PW7018LC**

Charge your USB-C laptop with up to 65W of power delivery, while charging other mobile devices. Stay charged conveniently with voltage input profiles of 5V/3A, 9V/3A, 15V/3A, and 20V/3.25A for uninterrupted productivity on the go.

[Read More](#)



Dell Notebook Power Bank Plus **- 65Wh - PW7015L**

With up to 65W power delivery, the Dell Notebook Power Bank Plus charges your laptop and up to two mobile USB devices simultaneously for productivity on the go.

[Read More](#)

DELL
CHARGING CARTS





CHARGING CARTS



Navigate seamlessly through the school day with a charging cart that offers safe and convenient storage and efficient charging for up to 36 devices.



Store, charge and transport

Securely store, efficiently charge and easily transport up to 36 laptops, chromebooks or tablets between classrooms, laboratories and libraries in school.



Flexible Design

Easily remove or adjust the shelves and fit up to 15" laptops within the cart.



Safe and Secure

A locking mechanism and optional padlock on selected models* keep your laptops secure, for peace of mind.

* Available on Dell CT36U18 and CT36UC20 only.



CHARGING CARTS



**Dell Network Ready
Charging Cart**
30 Devices - CT30N181

Protect your technology investment with the Dell Network Ready Charging Cart. Featuring Power Shuttle 2.0 and pre-routed CAT 6 Ethernet cables, securely store and charge up to 30 devices.

[Read More](#)



**Dell Compact USB-C
Pre-Wired Charging Cart**
36 Devices - CT36UC20

Pre-Wired with 36 USB-C power adapters, you can conveniently charge up to 36 USB-C devices stored in the cart, eliminating cable clutter and saving valuable time without the need for on-site wiring.

[Read More](#)



**Dell Compact
Charging Cart**
36 Devices - CT36U18

Dell Compact Charging Cart enables your devices to be efficiently charged thanks to Ergotron PowerShuttle 2.0 technology—which efficiently manages power distribution to your devices, optimizing the charging time.

[Read More](#)

DELLTechnologies

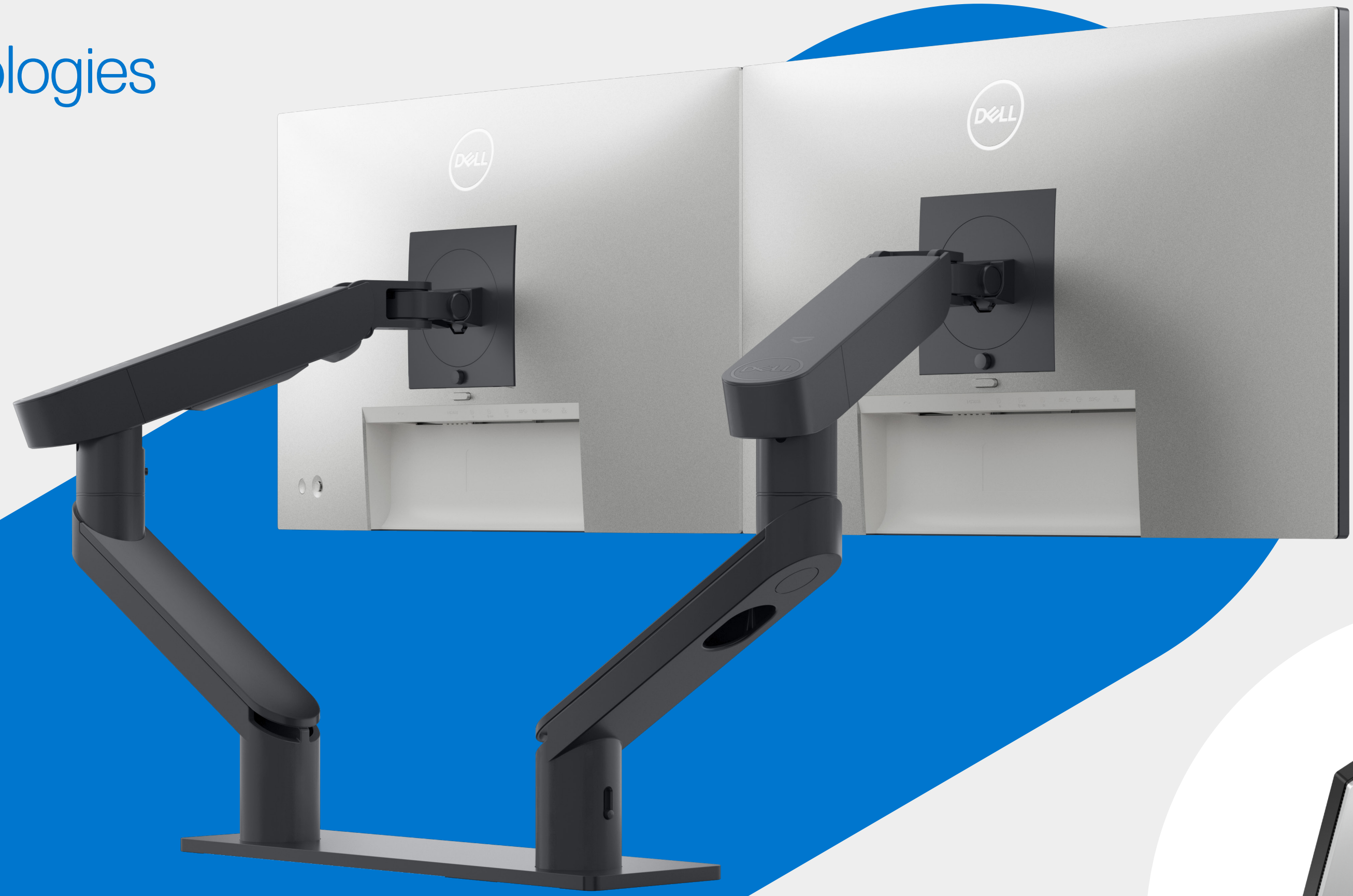

DELL
ARMS & STANDS



ARMS & STANDS



Optimize your workspace with arms and stands designed to perfectly complement Dell monitors, from the world's #1 monitor company¹.



CONVENIENT MOUNTING SOLUTIONS

Set up your VESA-compliant monitor with a Dell arm or stand effortlessly, with virtually tool-free assembly.



SUPERB ADJUSTABILITY

Tilt, pivot, swivel and adjust the height of your monitor to your preferred angle for all day comfort.



THOUGHTFULLY DESIGNED

Create the ultimate clutter-free workspace with a Dell arm or stand that cleverly conceals cables within a small footprint.

1. Source: IDC Worldwide Quarterly PC Monitor Tracker 2022Q1



ARMS & STANDS



ARMS

Optimize viewing comfort and desk space with a flexible arm that delivers enhanced monitor adjustability.

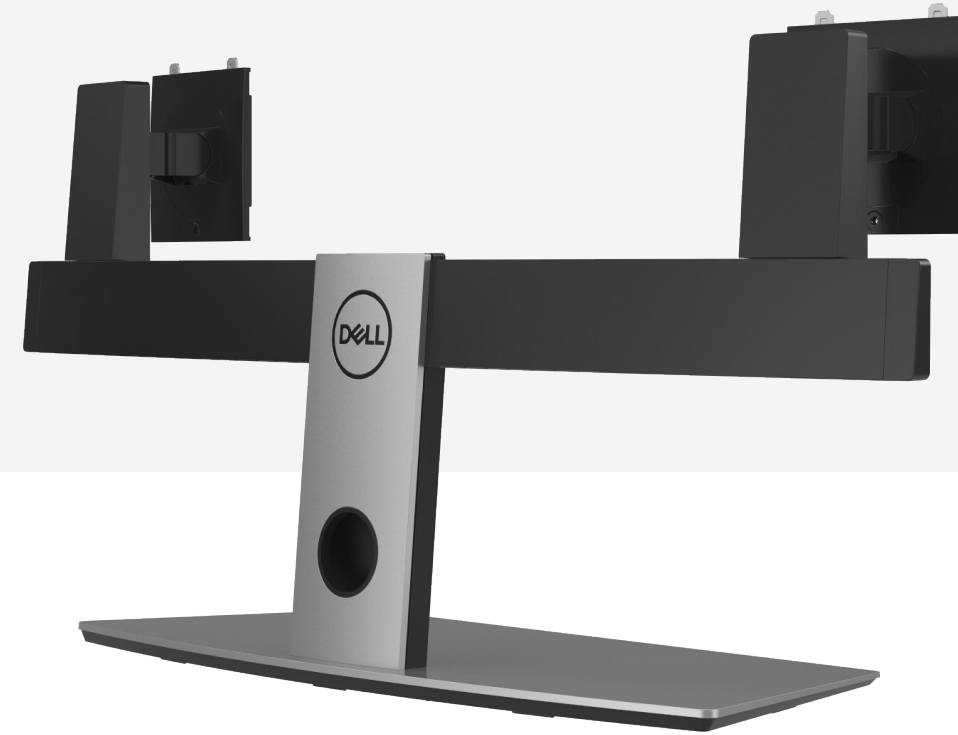
[Read More](#)

STANDS

Streamline your desk space with a sturdy dual stand that allows you to mount up to two 27" monitors effortlessly.

[Read More](#)

ALL-IN-ONE STANDS

Securely house both a PC and monitor within a small footprint with our convenient All-In-One stands.

[Read More](#)



ARMS & STANDS



Dell Single Monitor Arm
– MSA20

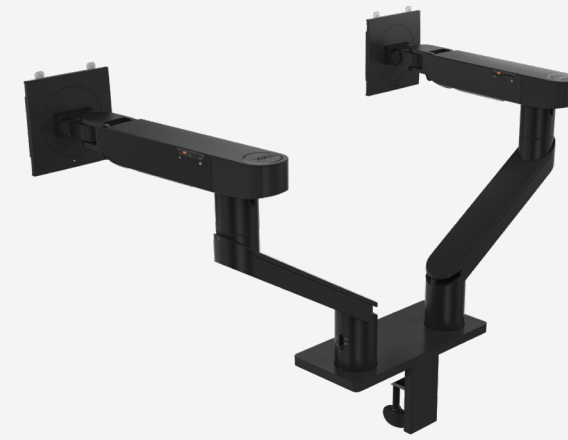

Dell Dual Monitor Arm
– MDA20



Dell Dual Monitor Stand
– MDS19

MONITOR COMPATIBILITY	19" to 38" (monitor mounting only). For PC and monitor mounting*	19" to 27" (monitor mounting only). For PC and monitor mounting*	Up to 27" monitors 4.9-13.2 lbs. (2.2-6.0 kg)
PIVOT	Portrait or landscape	Portrait or landscape	Portrait or landscape
TILT	-35° to +80°	-35° to +80°	-5° to +24°
SWIVEL	Switchable 180° and 360° at base and joint. 180° at monitor	Switchable 180° and 360° at base and joint. 180° at monitor	- 10° to +15° (Individual)
HEIGHT ADJUSTABILITY	10.5" (26.6cm)	10.5" (26.6cm)	5.1" (13.0 cm)
CABLE MANAGEMENT	Cable management slot with cable clips on the upper and lower arms (up to 10 cables)	Cable management slot with cable clips on the upper and lower arms (up to 10 cables)	Cable clips and cable management slot
DEPTH ADJUSTMENT	21.6" (54.8cm)	21.6" (54.8cm)	N.A.
	Read More	Read More	Read More

*Please refer to the PC compatibility section on Dell.com



ALL-IN-ONE STANDS



Dell OptiPlex Micro All-in-One Stand - MFS22

OptiPlex MFF 7000
OptiPlex MFF 5000
OptiPlex MFF 3000
OptiPlex Thin Client 3000



Dell Precision Compact All-in-One Stand - CFS22

Precision 3260 CFF



Dell Small Form Factor All-in-One Stand - OSS21

OptiPlex 3000 SFF, 3080 SFF, 3090 SFF, 5000 SFF, 5080 SFF, 5090 SFF, 7000 SFF, 7080 SFF, 7090 SFF, XE4 SFF, Precision Workstation 3440 SFF, 3440 XE, 3450 SFF, 3450XE SFF, 3460 SFF, 3460XE SFF, Vostro 3710 SFF

ALL-IN-ONE COMPATIBILITY

MONITOR COMPATIBILITY

SECURITY

PORTABILITY

HEIGHT ADJUSTABILITY

CABLE MANAGEMENT

Selected 19" to 27" UltraSharp, P, E and C series monitors. E series monitors require the use of VESA Adapter

K-Lock & Pad-Lock

Retractable handle

5.90" (15cm)

- Cable routing hole on bottom side of Cable Cover.
- Cable Routing Clips on the front of Stand Interposer to dress excess cable length.
- Pass-through hole on stand to route external cables to MFF/Monitor.

[Read More](#)

Selected 19" to 27" UltraSharp, P, E and C series monitors. E series monitors require the use of VESA Adapter

K-Lock & Pad-Lock

Retractable handle

5.90" (15cm)

- Cable routing hole on bottom side of Cable Cover
- Cable Routing Clips on the front of Stand Interposer to dress excess cable length.
- Pass-through hole on stand to route external cables to CFF/Monitor

[Read More](#)

OptiPlex 3000 SFF, 3080 SFF, 3090 SFF, 5000 SFF, 5080 SFF, 5090 SFF, 7000 SFF, 7080 SFF, 7090 SFF, XE4 SFF, Precision Workstation 3440 SFF, 3440 XE, 3450 SFF, 3450XE SFF, 3460 SFF, 3460XE SFF, Vostro 3710 SFF

K-Lock & Pad-Lock

Retractable handle

5.3" (13cm)

Meshed cable cover
Cable tray

[Read More](#)

DELLTechnologies



DELL
CARRYING CASES



CARRYING CASES

Protect and carry your laptop in style. Choose between backpacks, briefcases and sleeves that are designed with sustainability and functionality in mind.

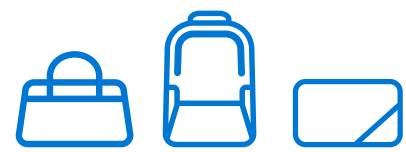

Features at a glance [➤](#)

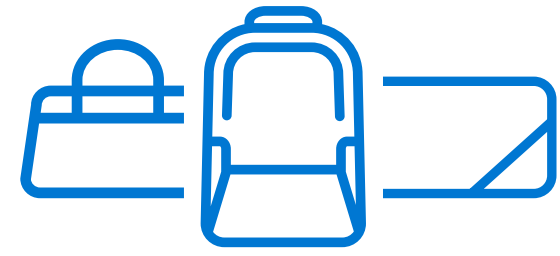

BENEFITS AT A GLANCE



PROTECT electronics
Durable **EVA foam cushioning** keeps your devices protected.

EcoLoop™

Designed with the environment in mind our EcoLoop series are manufactured with select materials and/or processes that help reduce environmental impact¹



TRAVEL at ease
Luggage handle pass-through to make travel easier.



CONVENIENCE
Convenient charging pass-through makes it easy to charge when you're on the go.

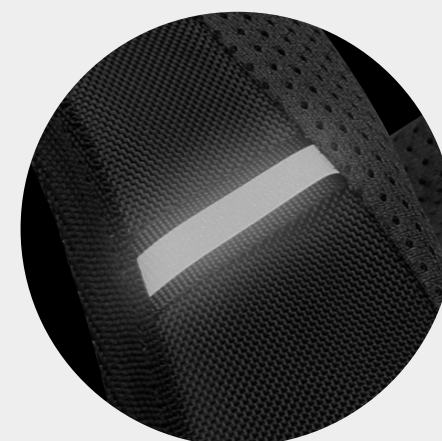

PROTECT the user
Reflective accents provide increased visibility during low-light conditions.



PROTECT carried items
Built with long-lasting, **water-resistant materials** that withstand the demands of everyday commuting.



* All images are for illustration purpose only. Features availability varies with different carrying cases.
¹ Sustainable practices and functionality vary by different products and models.



CREATED WITH THE ENVIRONMENT IN MIND



How Dell Carrying Cases make a difference

EcoLoop™

True to our Dell Technologies 2030 Sustainability Moonshot goals, all our EcoLoop™ label products are made with recycled materials and/or are manufactured using at least one of the following 5 processes that reduce the environmental impact.¹



OCEAN-BOUND PLASTICS

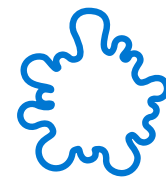

RESPONSIBLE DYEING PROCESS



RECYCLED WEATHERPROOFING



RECYCLED POLYETHYLENE TEREPHTHALATE (RPET)



RECYCLED CONTENT PACKAGING



¹Sustainable practices vary by product model; please refer to the product pages on Dell.com.

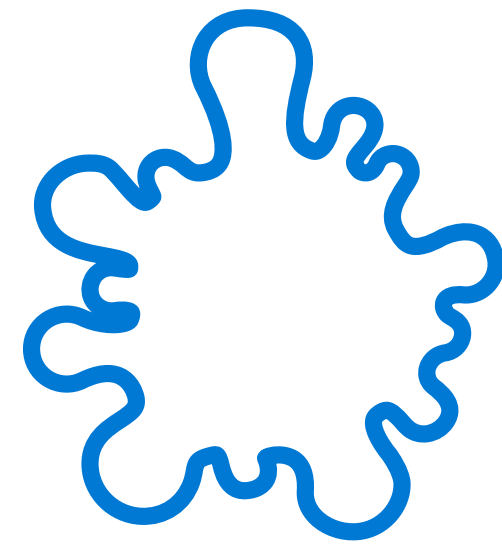

Responsible Dyeing Process

Through our responsible dyeing process, fabrics are woven from solution-dyed yarns, incorporating colour directly into the fibers prior to weaving. This process can generate up to **90% less wastewater**, up to **62% less CO₂ emissions**, and use up to **29% less energy** than traditional dyeing processes.³

³ Based on internal analysis of published data on solution-dyed virgin polyester, January 2022.



**90% less
wastewater**

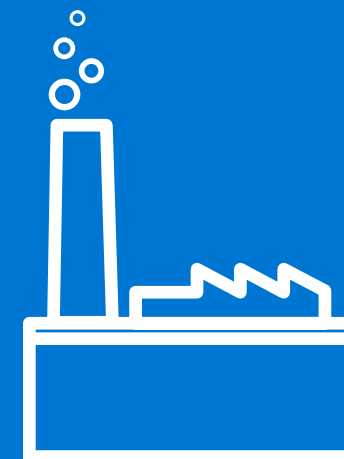

**up to 62% less
CO₂ emissions**



**up to 29%
less energy**

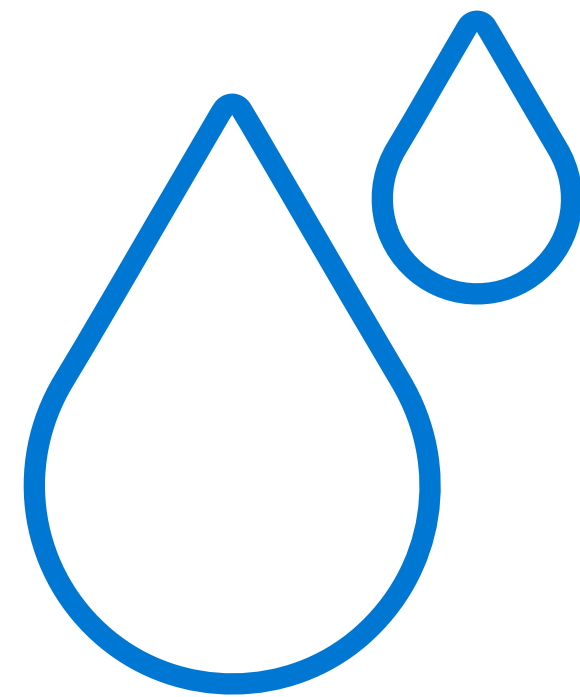

Recycled Weatherproofing

Fabric-coating is made from recycled PVB film⁴ recovered from used car windshields, which helps keep **materials out of landfills**.

⁴ Based on Internal Analysis of published data on recycled PVB film recovered from used car windshields, March 2022.



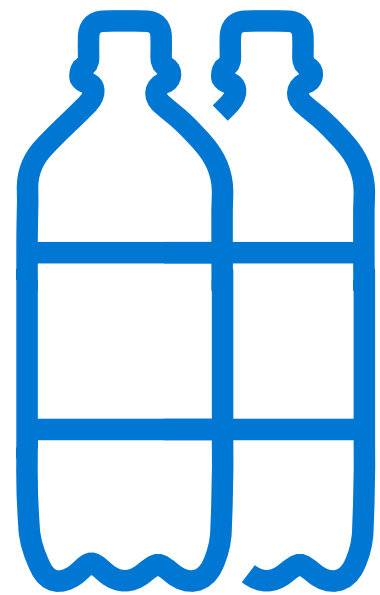

Recycled Polyethylene Terephthalate (rPET)

Selected products are constructed partially from **post-consumer recycled** PET (rPET). By using recycled materials, we've diverted 12 metric tons of recycled plastic, equivalent to 1 million plastic bottles.⁵

⁵ Based on internal analysis, Jan. 2022. Plastic bottle estimate assumes a 500ml plastic water bottle.

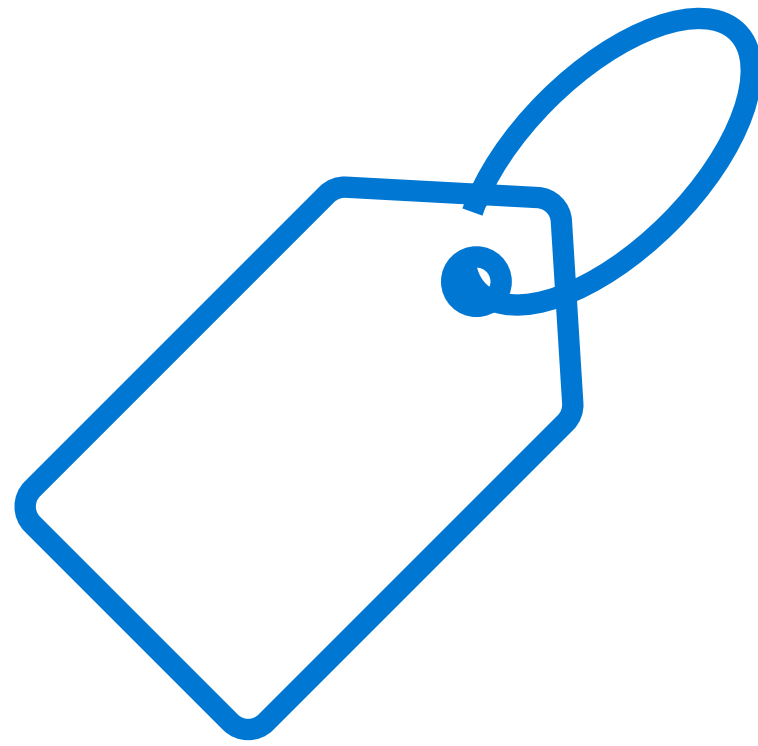

Recycled Content Packaging

Our hang tags, hang loops, and plastic bags are constructed using **100% recycled content.**





Ocean-bound Plastic

By incorporating ocean-bound plastics into select products, we've diverted 132 metric tons of ocean-bound plastic² from ocean coastlines and major waterways. That's equivalent to 14 million plastic water bottles.²

Each year, an estimated 11 million metric tons of plastic waste enter the Earth's Oceans.⁵ To help remedy the ocean plastic crisis, Dell Pro series exterior main fabric is made with 100% ocean-bound plastic certified by OceanCycle™.⁶

EcoLoop™



*Only applicable to the exterior main fabric on Dell Pro series

OceanCycle Certification Criteria



Material Collection:

Fits within OceanCycle's standards of proximity to the coastline in an area of mismanaged waste.



Ethically Sourced:

Must be post-consumer waste from the location of origin and collected in an ethical manner ensuring no harmful child labor and fair wages waste.



Environmental Practices:

Wastewater and chemicals must be disposed properly.



Documentation:

Compliance with Ocean Cycle's end-to-end traceability, documented from bottle collection through to manufacturing.

² Based on internal analysis, Jan. 2022. Plastic bottle estimate assumes a 500ml plastic water bottle
⁵ Source : Source: <https://oceancycle.co/ocean-bound-plastic-certification/>
⁶ OceanCycle Certified™ purchased yarn. Ocean-bound plastic is waste collected within 50 kilometers (30 miles) of an ocean coastline or major waterway.



CARRYING CASES

Choose the right Dell Carrying Case for you

Whether you're looking for something premium, affordable, eco-conscious, or fashion-forward—we've got you covered.



EXPLORE
CARRYING CASES



PREMIER SERIES



PRO SERIES



PRO SLIM SERIES



ESSENTIAL SERIES



URBAN BACKPACK



GAMING BACKPACK

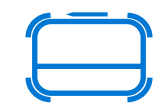

COMMERCIAL GRADE CASE





DELL PREMIER SERIES BACKPACKS & BRIEFCASES



EcoLoop™

The ultimate travel companion

Stay connected no matter where you are. These TSA checkpoint-friendly carriers let you breeze through security without removing your laptop. Convenient in-bag charging and padded compartments make the Dell Premier series the ideal choice for easy travel.



Features at a glance



Dell EcoLoop Premier Backpack 15
- PE1520P



Fits most
Dell Laptops up to 15.6"

[Read More](#)



Dell EcoLoop Premier Slim Backpack 15
- PE1520PS



Fits most
Dell Laptops up to 15.6"

[Read More](#)



Dell EcoLoop Premier Briefcase 15
- PE1520C



Fits most
Dell Laptops up to 15.6"

[Read More](#)



Dell EcoLoop Premier Backpack 15 - PE1520P
Dell EcoLoop Premier Slim Backpack 15 - PE1520PS
Dell EcoLoop Premier Briefcase 15 - PE1520C



Made with **responsible dyeing process** and **recycled** weatherproofing



TSA checkpoint-friendly design unzips to lay flat for screening (Applicable to Premier Backpack and Briefcase only)



Dedicated laptop compartment with **EVA foam protection** and tablet sleeve



Premium **1680D Ballistic Polyester** with black leather accents



Padded main compartment



Front organizer compartment with **zippered pocket**



Zippered **leather** front pocket



Discreet valuables top pocket



Attach to rolling luggage for easy travel



Convenient **in-bag charging** when on the go



DELL PREMIER SERIES SLEEVES



EcoLoop™

Where style meets function

Combining premium aesthetics and a functional design, the Dell EcoLoop Leather Sleeve offers stylish protection for your Latitude 9000 series laptop



Dell EcoLoop Leather Sleeve 14 - PE1422VL



Fits most
Dell Laptops up to 14"



Features at a glance



[Read More](#)



Dell EcoLoop Leather
Sleeve - 14 PE1422VL



50% recycled content
(Exterior: 50% recycled leather fibers¹;
Interior: 50% post-consumer recycled polyester¹)



Lightweight, sleek design
with a laser-cut pattern



Secure and snug fit with **zippered closure**



Water-resistant exterior



Dedicated **pen holder** within sleeve

¹ Based on internal analysis of published data on solution-dyed virgin polyester, January 2022



DELL PRO SERIES BACKPACK & BRIEFCASE



EcoLoop™



*Only applicable to the exterior main fabric on Dell Pro series

Impact-resistant protection for your laptop designed with the environment in mind

Designed for on-the-go productivity, the Dell EcoLoop Pro Briefcase or Backpack conveniently stores your laptop, accessories, documents, and more. The 360-degree foam cushioning built around the laptop vault will keep your computing devices protected in case of impact. Made with durable, weather-resistant materials, you can rest assured it will stand up to the demands of everyday commuting.



Features at a glance



Dell EcoLoop Pro Backpack - CP5723



Fits most
Dell Laptops up to 17"

[Read More](#)



Dell EcoLoop Pro Briefcase - CC5623



Fits most
Dell Laptops up to 16"

[Read More](#)

Dell EcoLoop Pro Backpack - CP5723

Dell EcoLoop Pro Briefcase - CC5623



OceanCycle Certified™ ocean-bound plastic, the exterior is made with **100% ocean-bound plastic**¹



Made with **responsible dyeing process** and recycled weatherproofing



Packaging is made with **100% recycled content** in the hang tag, hang loop, and plastic bag



Dedicated laptop compartment with **360-degree foam protection** (EVA foam at the bottom and mesh bumper at the top) and tablet sleeve



Purpose-built organizers for keyboard, mouse, headset, and other tech accessories



Spacious main compartment



Anti-scratch **Nylex lining** for laptop



Weather-resistant, premium **840D Ballistic** body fabric



Attach to rolling luggage for easy travel



Reflective accents for increased visibility during low-light hours

¹ OceanCycle Certified™ purchased yarn. Ocean-bound plastic is waste collected within 50 kilometers (30 miles) of an ocean coastline or major waterway.



DELL PRO SERIES SLEEVES



EcoLoop™



*Only applicable to the exterior main fabric on Dell Pro series

Impact-resistant protection for your laptop designed with the environment in mind

Protect your laptop and everyday essentials with an eco-conscious Dell Pro Sleeve that's light and easy to carry on its own, or slips easily inside your favorite bag when you're on the move.



Features at a glance



Dell EcoLoop Pro Sleeve 15-16
- CV5623



Fits most
Dell Laptops up to 16"

[Read More](#)



Dell EcoLoop Pro Sleeve 11-14
- CV5423



Fits most
Dell Laptops up to 14"

[Read More](#)

Dell EcoLoop Pro Sleeve 15–16 - CV5623

Dell EcoLoop Pro Sleeve 11–14 - CV5423



OceanCycle Certified™ fabric, the exterior is made with **100% ocean-bound plastic**¹



Made with **responsible dyeing process** and recycled weatherproofing



Packaging is made with **100% recycled content** in the hang tag, hang loop, and plastic bag



Front zippered pocket with organizers to store charger, mouse, and pens



Attach to rolling luggage for easy travel



Padded handles and detachable shoulder straps



Anti-scratch **Nylex lining** protects against spills, bumps, and scratches



Weather-resistant, **premium 840D Ballistic body fabric**



DELL PRO SLIM SERIES BACKPACK & BRIEFCASE



EcoLoop™

Your dependable everyday companion

Keep your laptop, tablet, and other essentials securely protected within the eco-conscious Dell Pro Slim Briefcase or Backpack, a slim-fit bag designed for work and beyond.



Features at a glance



Dell Pro Slim Backpack 15 - PO1520PS



Fits most
Dell Laptops up to 15.6"

[Read More](#)



Dell Pro Slim Briefcase 15 - PO1520CS



Fits most
Dell Laptops up to 15.6"

[Read More](#)

Dell Pro Slim Backpack 15 - PO1520PS

Dell Pro Slim Briefcase 15 - PO1520CS



Made with **responsible dyeing process** and **recycled weatherproofing**



Lightweight with **spacious compartment**



Padded laptop and tablet sleeve



Internal organizer pockets



Reflective accents for **increased visibility** during low-light conditions



Weather resistant, **durable body fabric**



BRIEFCASE **ONLY** FEATURES



Attach your briefcase to rolling luggage for **easy travel**



Convenient **in-bag charging** when on the go



DELL ESSENTIAL SERIES BACKPACK, BRIEFCASE & SLEEVE



Stay safe on the go

Store your most valuable items in the Dell Essential Backpack, Briefcase, or Sleeve - secure bags that are designed with reflective elements to keep you visible in low light while staying lightweight and comfortable enough to keep you hands-free on the go.



Dell Essential Backpack 15
- ES1520P



Fits most
Dell Laptops up to 15.6"

[Read More](#)



Dell Essential Briefcase 15
- ES1520C



Fits most
Dell Laptops up to 15.6"

[Read More](#)



Dell Essential Sleeve 13 / 15
- ES1320V / ES1520V



Fits most
13" (E1320V) and 15.6" (ES1520V)

[Read More](#)



Features at a glance



Dell Essential Backpack 15 - ES1520P

Dell Essential Briefcase 15 - ES1520C



Lightweight



Zippered front pocket



Padded laptop sleeve and **large main compartment** (Backpack)



Reflective graphic print



Water-resistant outer material



Trolley strap for easy attachment to rolling luggage (Briefcase)



Dell Essential Sleeve 13 / 15

- ES1320V / ES1520V



Lightweight design



Durable, **water-resistant**, form-fitting neoprene sleeve



Soft, **Nylex inner lining** helps protect your device against scratches



Double-zipper design allows durable zippers to glide smoothly and allows convenient access to your laptop



Wide sleeve opening



DELL URBAN BACKPACKS



EcoLoop™

Designed for organization and comfort to suit any lifestyle

A backpack as stylish and adventurous as you, the Dell EcoLoop Urban Backpack is built with the environment in mind and delivers an elevated look perfect for any office, gym, or weekend getaway. Choose from blue or gray to best suit your style.



Features at a glance



Dell EcoLoop Urban Backpack
- CP4523B (Blue)



Fits most
Dell Laptops up to 15"

[Read More](#)



Dell EcoLoop Urban Backpack
- CP4523G (Grey)



Fits most
Dell Laptops up to 15"

[Read More](#)



Dell EcoLoop Urban Backpack

- CP4523B (Blue) / CP4523G (Grey)



Exterior fabric is made with **100% recycled plastic**, approximately seven recycled plastic bottles¹



Packaging made with **100% recycled content** in the hang tag, hang loop, and plastic bag



Padded **dedicated laptop sleeve**



Spacious main compartment



Front organizer panel for accessories



Vertical **zippered front pocket** for essentials



Two **mesh side pockets**



Reflective accents for **increased visibility** during low-light hours



Durable Weather-resistant, 420D Ballistic body fabric

¹ Plastic bottle estimate assumes a 500ml plastic water bottle



DELL GAMING BACKPACK



Work hard, play harder

Weather-resistant, easy to carry, and practical, Dell Gaming Backpacks are designed for the stylish gamer. Look cool while carrying all your gaming equipment comfortably with a vibrant rainbow-hued reflective panel laptop bag.



Features at a glance



Gaming Backpack 17 - GM1720PM



Fits Dell G Series
gaming laptops Series

[Read More](#)



Gaming Backpack 17 - GM1720PM



Designed for Dell G Series laptops; **Up to 17"**



Multichromatic reflective accents for safety in low-light conditions



Dedicated laptop sleeve and **multiple accessory pockets** keep hardware protected and organized



Deployable **rain cover** protects contents from adverse weather conditions



Airflow channel design and **breathable air mesh back padding** keeps back ventilated



Adjustable, padded straps with air mesh and a **chest strap** with **quick-release buckle**



Attach to rolling luggage for easy travel



DELL COMMERCIAL GRADE CASE

EcoLoop™

**Eco-conscious rugged protection
that follows you anywhere**

Wherever your projects take you,
keep your Dell Latitude 7320 Detachable
protected and secure with the lightweight
and rugged Commercial Grade Case.



Features at a glance



Dell EcoLoop Commercial Grade Case - RG1322C



Fits Dell Latitude
7320 Detachable

[Read More](#)



Dell EcoLoop Commercial
Grade Case - RG1322C



Fits Latitude 7320 Detachable



Made of **24% recycled content**¹



Form-fitting, shock-absorbing **TPU bumper** for all-around protection



Wedge-shaped and **T-bar lock slots**



Facilitates hands-free viewing



Hand strap and detachable shoulder strap



Compatible with Latitude 7320 Detachable **travel keyboard**



Built-in **active pen holder**

¹ Chassis is made with 30% recycled polycarbonate by weight. Shoulder strap is made with 25% recycled polyester by weight



OVERVIEW

EcoLoop Briefcases and Backpacks



	PREMIER SERIES		PRO SERIES	PRO SLIM SERIES	URBAN SERIES
MODEL	PE1520P, PE1520C	PE1520PS	CC5623, CP5723	PO1520CS, PO1520PS	CP4523B, CP4523G
DESIGNED FOR	Dell Latitude 9000 and 7000 series, XPS and Precision		Dell Latitude 5000 series and Precision	Dell Latitude 3000 series	Dell Vostro and Inspiron
COMPATIBILITY	Fits most Dell Laptops up to 15.6"		Fits most Dell Laptops up to 16" (CC5623) & up to 17" (CC5723)	Fits most Dell Laptops up to 15.6"	Fits most Dell Laptops up to 15"
ECO-MATERIAL	EcoLoop™		EcoLoop™	EcoLoop™	EcoLoop™
CHARGING PASS THROUGH					
LUGGAGE HANDLE PASS-THROUGH					
EVA FOAM PROTECTION	EVA+	EVA+	EVA+		
GENUINE LEATHER					
TSA COMPLIANT	TSA*				
REFLECTIVE ACCENTS					

* Only available for PO1520CS



Dell Carrying cases

OVERVIEW - BY SERIES

PRODUCT NAME	PRODUCT NUMBER
PREMIER SERIES	
Dell EcoLoop Premier Backpack 15	PE1520P
Dell EcoLoop Premier Briefcase 15	PE1520C
Dell EcoLoop Premier Slim Backpack 15	PE1520PS
Dell EcoLoop Leather Sleeve 14	PE1422VL
PRO SERIES	
Dell EcoLoop Pro Backpack	CP5723
Dell EcoLoop Pro Briefcase	CC5623
Dell EcoLoop Pro Sleeve 11-14	CV5423
Dell EcoLoop Pro Sleeve 15-16	CV5623
PRO SLIM SERIES	
Dell Pro Slim Backpack 15	PO1520PS
Dell Pro Slim Briefcase 15	PO1520CS
ESSENTIAL SERIES	
Dell Essential Backpack 15	ES1520P
Dell Essential Briefcase 15	ES1520C
Dell Essential Sleeve 13	ES1320V
Dell Essential Sleeve 15	ES1520V
OTHERS	
Dell EcoLoop Urban Backpack (Blue)	CP4523B
Dell EcoLoop Urban Backpack (Gray)	CP4523G
Dell Gaming Backpack 17	GM1720PM
Dell EcoLoop Commercial Grade Case	RG1322C



Dell Carrying cases

OVERVIEW - BY TYPE

PRODUCT NAME	PRODUCT NUMBER
BACKPACKS	
Dell EcoLoop Premier Backpack 15	PE1520P
Dell EcoLoop Premier Slim Backpack 15	PE1520PS
Dell EcoLoop EcoLoop Pro Backpack	CP5723
Dell Pro Slim Backpack 15	PO1520PS
Dell Essential Backpack 15	ES1520P
Dell EcoLoop Urban Backpack (Blue)	CP4523B
Dell EcoLoop Urban Backpack (Gray)	CP4523G
Dell Gaming Backpack 17	GM1720PM
BRIEFCASES	
Dell EcoLoop Premier Briefcase 15	PE1520C
Dell EcoLoop Pro Briefcase	CC5623
Dell Pro Slim Briefcase 15	PO1520CS
Dell Essential Briefcase 15	ES1520C
SLEEVES	
Dell EcoLoop Leather Sleeve 14	PE1422VL
Dell EcoLoop Pro Sleeve 11-14	CV5423
Dell EcoLoop Pro Sleeve 15-16	CV5623
Dell Essential Sleeve 13	ES1320V
Dell Essential Sleeve 15	ES1520V
OTHERS	
Dell EcoLoop Commercial Grade Case	RG1322C

DELL Technologies



DELL
SOFTWARE





DELL PERIPHERAL MANAGER

Get more done with an elevated work experience from Dell Peripheral Manager. Through this free-to-download software, you can enable and configure advanced features¹ in select Dell Accessories, maximizing the performance of your devices for ultimate productivity.

[Download Dell Peripheral Manager](#)

[Supported Accessories](#)

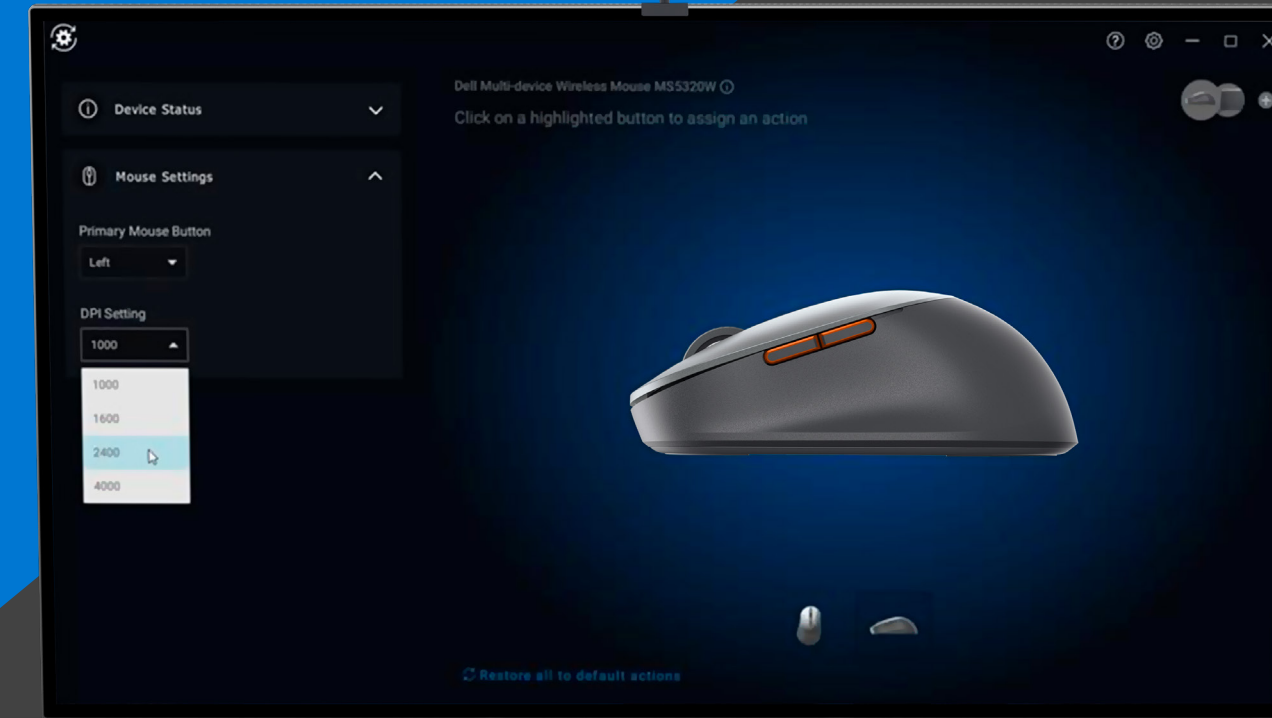

KEYBOARDS AND MOUSE

Customize your keyboards and mice to suit the way you work. You can also program the keys /buttons, sync your devices, check device and battery status and upgrade to the latest firmware.

[Read More](#)



ACTIVE PENS

Optimize your productivity with customizable shortcut buttons that allow you to adjust tilt and tip sensitivity, enhancing your writing experience.

[Read More](#)



WEBCAMS AND VIDEO CONFERENCING MONITORS²

Adjust the color, brightness, sharpness and contrast of your on-screen appearance and more using advanced webcam and conferencing controls³.

[Read More](#)



AUDIO DEVICES

Take your listening experience and privacy control to the next level with the latest in easy-to-use equalizer settings and intelligent noise cancellation.

[Read More](#)

¹ Features availability varies with different devices and model

² Dell Peripheral Manager is used to enable the camera settings for your video conferencing monitors only. For other settings for your video conferencing monitors, please use the Dell Display Manager software available at www.dell.com/ddm

³ Dell Peripheral Manager is compatible with Microsoft Windows 10 and 11 operating systems only. To enable advanced features for webcams and camera displays for Mac OS, please download the Dell Display and Peripheral Manager software at www.dell.com/support/ddpm



DELL PAIR

Dell Pair¹ is the simple and secure way to connect with your accessories.

Supported PCs and Accessories

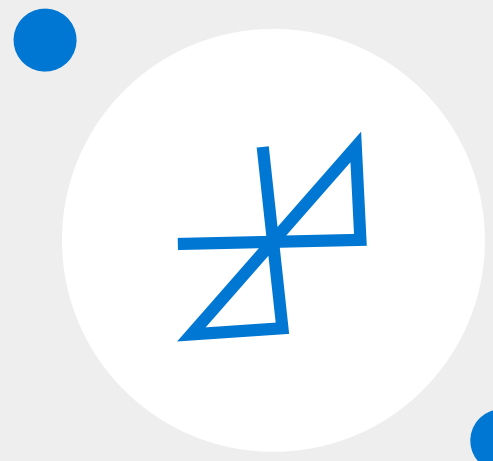

SECURE AND SEAMLESS CONNECTION

Stay protected and minimize risk of hacking while pairing your accessories. This software meets the [strongest security standards](#) for Bluetooth[®] low-energy pairing of keyboard and mice².

EASY SET UP

Simply place your Dell accessories¹ next to a compatible Dell PC. Accessories are detected automatically and can be paired with only one click.³

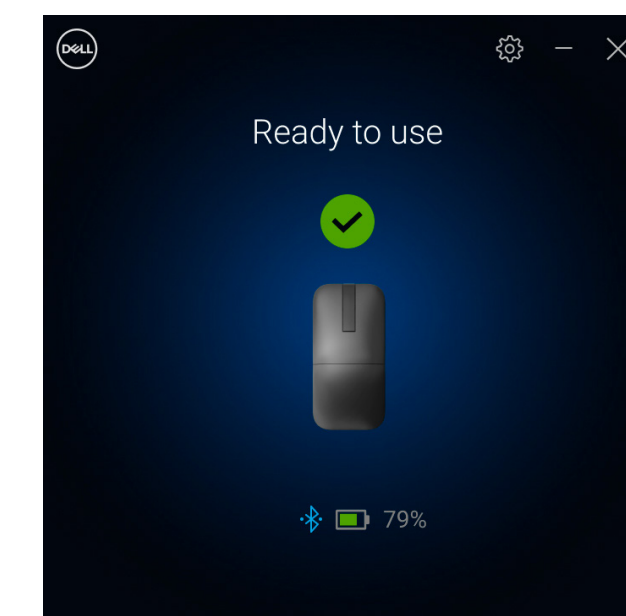
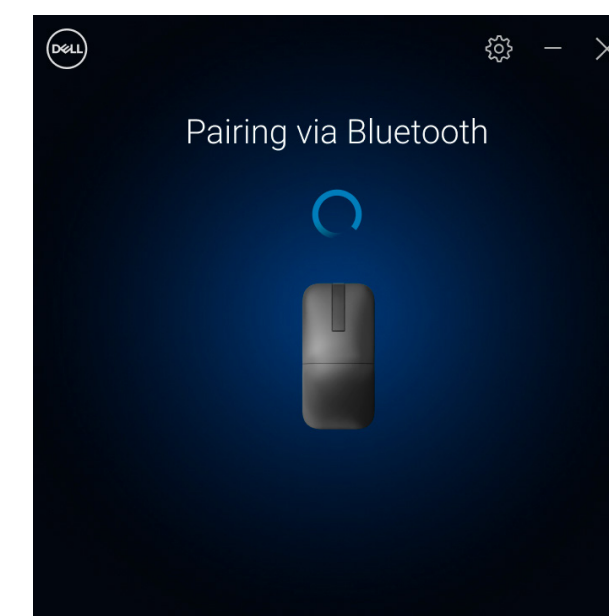
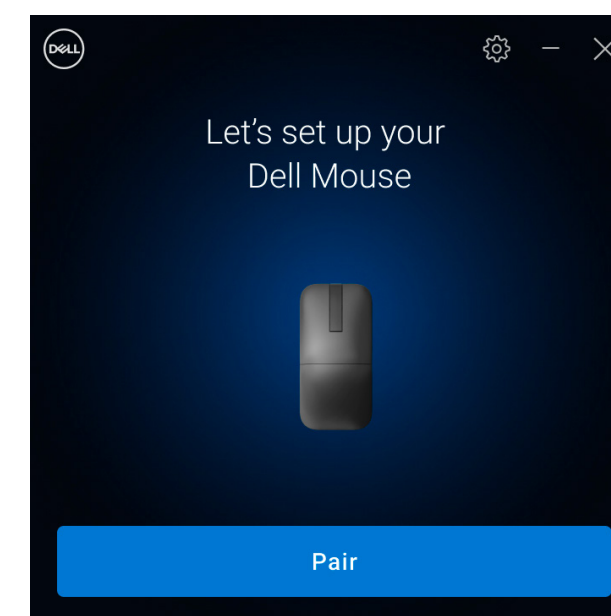

¹ Dell Pair is available with select commercial and consumer PCs; availability and functionality vary by model. For more details visit [Dell.com/support/kbdoc/000201693](https://dell.com/support/kbdoc/000201693)
² Based on Dell Analysis, October 2022. For more details visit [Guide to Bluetooth Security https://nvlpubs.nist.gov/nistpubs/SpecialPublications/NIST.SP.800-121r2-upd1.pdf](https://nvlpubs.nist.gov/nistpubs/SpecialPublications/NIST.SP.800-121r2-upd1.pdf)
³ Based on initial pairing.

STRONGEST BLUETOOTH® SECURITY STANDARDS

Bluetooth Security Level 4

- Dell Pair utilizes authenticated Bluetooth® Low Energy(BLE) Secure Connections pairing
- Reduced proximity range for pairing, making it suitable for dense wireless environments
- Automated passcode exchange
- 256-bit secure key exchange encryption
- Dell Pair achieves Level 4 security even for keyboards & mice¹

¹ Based on Dell Analysis. October 2022.
For more details visit Guide to Bluetooth Security
<https://nvlpubs.nist.gov/nistpubs/SpecialPublications/NIST.SP.800-121r2-upd1.pdf>

